

**WAVE PROPAGATION
AND BROADBAND
COMMUNICATION
ENGINEERING**

[TH-04]

5TH SEM ELECTRONICS

&

TELECOMM. ENGG.

Under SCTEVT, Odisha

PREPARED BY :-

***Er . jasmine nessa* [lecture in Dept . of ETC ,BSE]**

CHAPTER-1

2 marks questions

1.What is Actual Height and Virtual Height ?

[2016 / 2017]

Ans- **Actual Height**:- It is the height at which the wave form returns from the ionosphere.

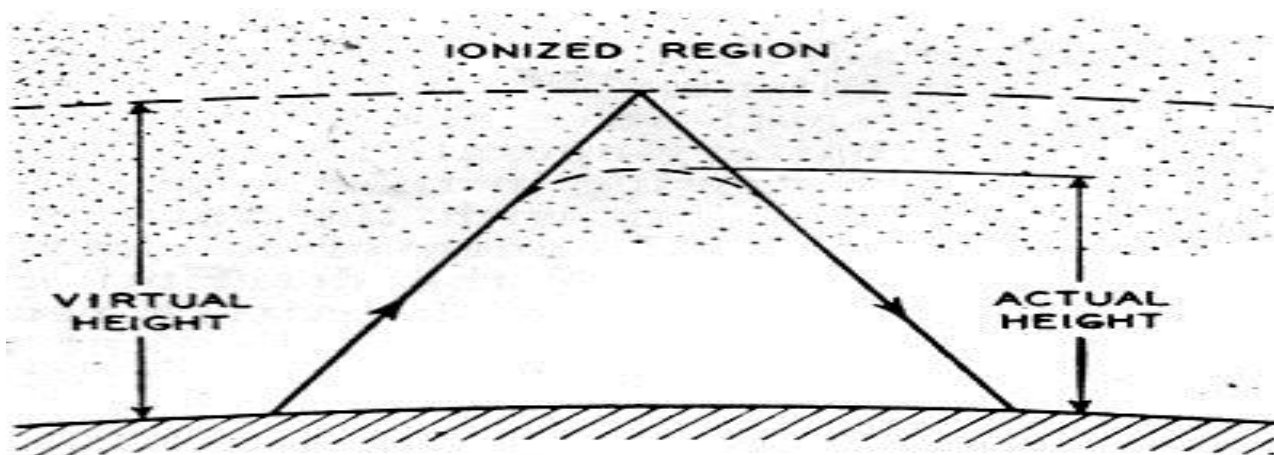

Virtual Height:- It is the height which would have been reached by the wave in ionosphere to get reflected rather than actual refracted at lower height in the ionosphere.

Long Questions (5marks & 7 marks)

1.Discuss different types of propagation wave ?

[2017]

Ans- The EM wave which propagates over the earth depends not only their own properties but also on their own environments. The various methods of propagation depends largely on frequency .

The mode of propagation classifies the radio wave into three categories-

- (i) Ground wave
- (ii) Sky wave
- (iii) Space wave

(i) **Ground wave** :-Ground wave travels along the surface of the ground . The ground behaves so as leaky capacitor. Therefore the ground wave get attenuated as it travels on the ground surface. Frequency used in this mode are up to 1600KHz .The ground wave is split into a surface wave and space wave. The space

wave is the result of two component waves, a direct wave and a ground reflected wave. When both the transmitting and receiving antenna are on earth surface, the direct wave and ground reflected at the receiving end are equal in magnitude opposite in phase, so that cancelled each other only the surface wave remain .This is called ground wave transmission as obtaining at medium wave length.

PRINCIPLE USED IN SPACE WAVE PROPAGATION

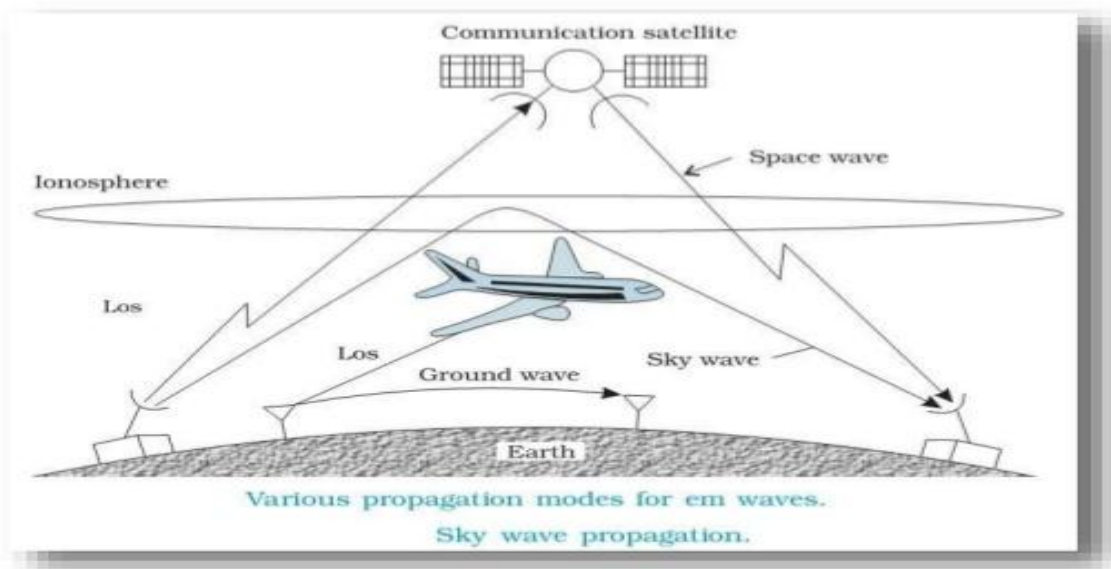

(ii) **Sky wave**:- Some radio waves reaches the upper part of the atmosphere known as ionosphere which acts like a mirror and reflects the wave back to earth. These waves are called sky wave .The frequencies used in this mode is up to 30MHz for propagation.

(iii)**Space wave** :- The frequencies above 30MHz having the attenuation of the ground wave is very high. More over these wave penetrate the wave propagate the ionosphere and are not reflected by it. Communication above 30MHz is through space wax. The reception of signals through space wave is limited to line of sight distance.

2.Discuss the effects of Environment relation to Reflection, Interference, Diffraction ?

[2016 / 2017]

Ans : - **Reflection**:-In reflection the angle of reflection is equal to the angle of incidence. Here the incident ray ,reflected ray and the normal at the point of incident are in one plane. In reflection the electric vector is perpendicular to the conducting surface, otherwise surface current will be set up and no reflection will occur. If the surface is curved , reflection will once again follow the optical law.

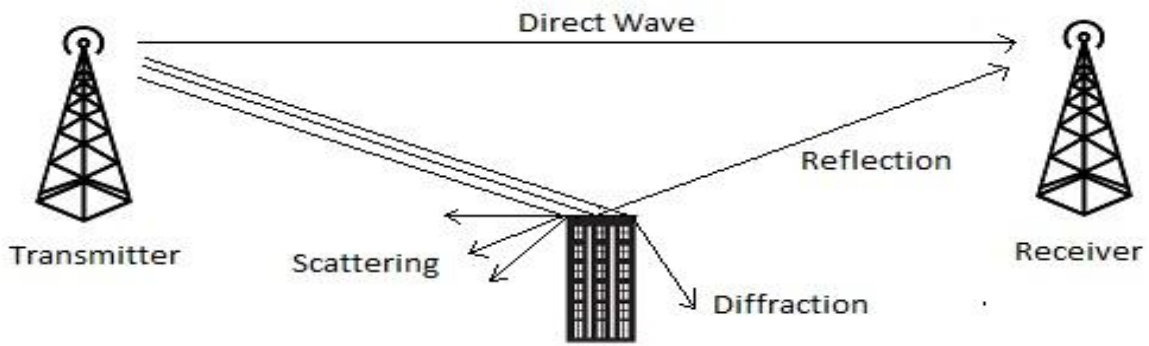

Refraction:-Refraction takes place when electromagnetic wave passes from one operating medium to other having different density. The relationship between angle of incidence and refraction is

$$\text{Refraction} = \frac{PP'}{\phi\phi'} = \frac{V_R}{V_A}$$

Where V_A - wave velocity in the medium A

V_B - wave velocity in the medium B

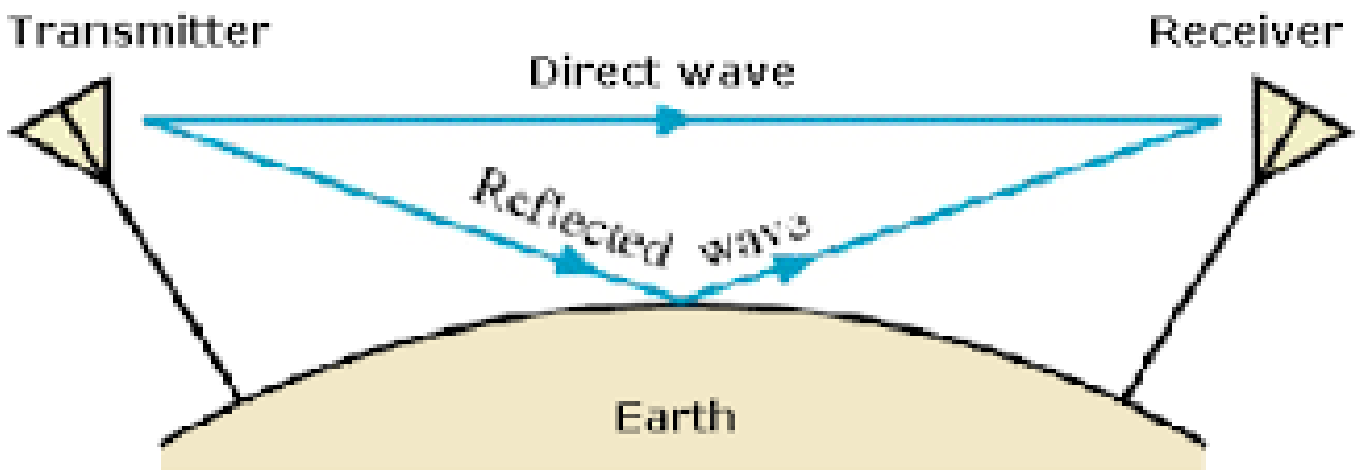

Space wave, comprising direct + reflected waves

The wave velocity in a dielectric is inversely proportional to the square root of the dielectric constant of the medium.

$$\text{Refraction} = \frac{\sin \theta'}{\sin \theta} = \sqrt{\frac{K}{K'}} = \frac{1}{\mu}$$

Where K' = Dielectric constant of medium A

K = Dielectric constant of medium B

μ = Refractive Index

Diffraction :-It is the properties shared with optics and concerned itself with the behavior of the electromagnetic waves in a conducting plane or sharp edge of obstacle. Diffraction occurs when the path is

blocked by large object related to land sharp irregularities. Secondary wavelets propagates into the shadow region. Deffraction gives rise to bending of wave around the obstacle.

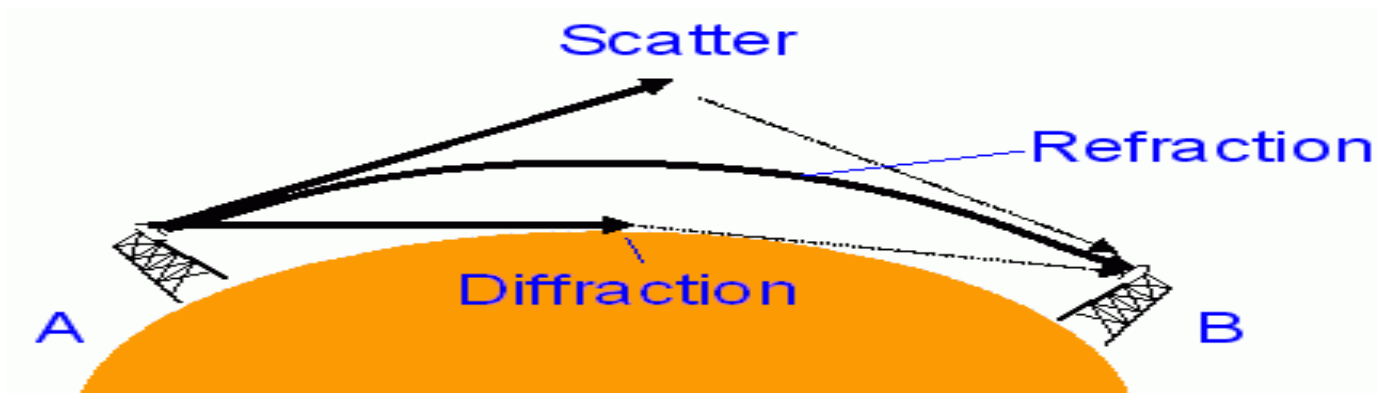

Interference:- Interference occurs when two waves having left one source and travel by different paths, arrive at a point. It occurs in high frequency sky wave and space wave propagation. Here the direct path is shorter than the path with reflection. It arises when a microwave antenna is located near the ground and wave reaches the receiving point after being reflected from the ground.

3.Explain Critical frequency, Maximum usable frequency, Skip distance, Fading, Tropospheric scatter propagation ? [2017]

Ans-Critical Frequency:-The highest frequency that the E_M wave returned to earth in vertical direction is called critical frequency.

Maximum Usable Frequency(MUF):- The highest frequency that returns to earth over a given path is called MUF.

There is a definite relation between critical frequency and MUF

$$F_M = F_C / \cos \theta$$

Where F_M =Maximum Usable Frequency

F_C =Critical Frequency

θ = Angle of incidence

Skip Distance:-The minimum distance from the transmitter along the surface of the earth at which a sky wave of given frequency is returned to earth by the ionospheric layers called skip distance.

Fading:- Fading is the fluctuation in signal strength at the receiver. It may be rapid or slow, general or frequency selective. Fading is due to interference between two waves which left the same source but arrived at the destination at different paths. The signal received at any instant is the vector sum of all the wave received, so attenuate cancellation may occur.

Fading can occur due to interference between the lower and upper ray of a sky wave, between sky wave arrives by different phase even between ground wave and a sky wave.

Tropospheric Scatter Propagation :- It is also called Tropospheric Forward Scattered Propagation. It means beyond the horizon propagation for UHF signal. It uses certain properties of troposphere (the nearest portion of atmosphere) within about 15 KM of the ground.

CHAPTER-2

2 marks questions

1. Define Beam width and Polarization? [2017,2019]

Ans:-**Beam Width** :-The beam width of an antenna is described as the angle created by the half power point (3db) on main radiation lobe to its maximum power point.

For Example angle is 30^0 which is the sum of two angle created at the points where the field strength drop to .707 of the maximum voltage at the center of the loop.

Polarization:-Polarization of an antenna refers to the direction in space of the E field (Electric vector) portion of the electromagnetic wave being radiated by the transmitting system.

Low frequency antenna are generally vertically polarized and high frequency antenna becomes horizontally polarized.

2. What do you mean by Smart antenna ?

[2016 / 2017]

Ans:-**Smart antenna**:-It is also known as adaptive array antenna/multi input antenna/MIMO. It is the antenna array with signal processing algorithm to identify direction of arrival(DOA) of the signal, calculate beam forming vector to track and locate the antenna beam on the mobile target.

It has two main function i.e. DOA Estimate and Beam Forming. It is used for signal processing ,track etc.

3. What is End fire antenna array ?

[2016]

Ans:- **End-fire antenna** :- A linear array whose direction of maximum radiation is along the axis of the array; it may be either unidirectional or bidirectional; the elements of the array are parallel and in the same plane, as in a fishbone antenna. Also known as end-fire antenna.

Long Questions (5marks & 7 marks)

1. Discuss about Yagi antenna with neat diagram and its advantages ?

[2016/2017/2019]

Ans:- **Yagi Antenna** :-The yagi antenna is an array consisting of driven element and one and more parasitic elements. An element directly connected to the transmitter is called driven element where as a radiator not directly connected is called a parasitic element element . Such a parasitic radiator receive energy through induction field of driven element rather than by a direct connection to the transmitter line.

The parasitic element longer than the driven and close it if it reduces signal strength in its own direction and increases it in opposite direction. It thus act as a manner similar to a concave mirror in optics and is called reflector. Again a parasitic element is shorter than the driven element

from which it receives energy tends to increase radiation in its own direction and therefore behave like a convergent convex lens. It is called director .

The gain and directivity of an half wave dipole antenna can be increased by the addition of reflector and one or more directors .The reflector gives unidirectional characteristics to the dipole antenna. In the spacing of parasitic is less than the directivity is increased . In such a case the radiation from the parasitic area is exactly not in phase with or in phase opposite to that from the area.

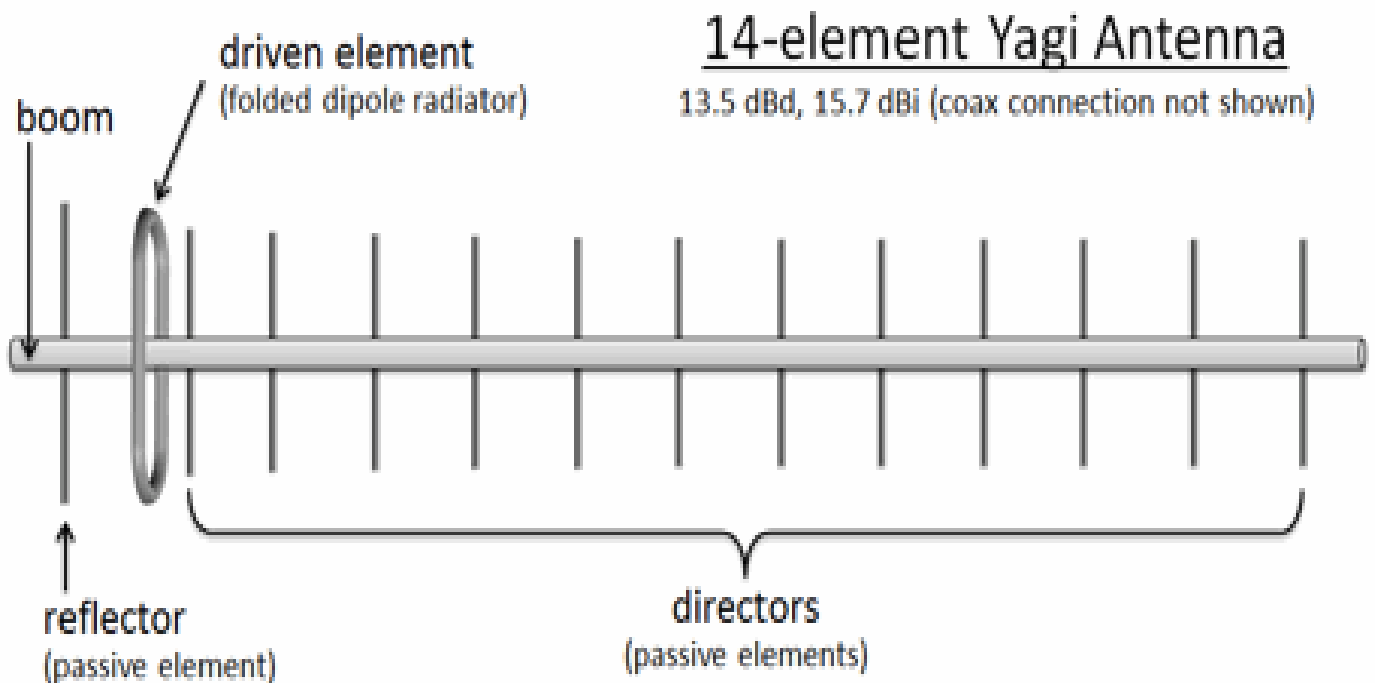

In yagi antenna reflector is usually 5% to 15% longer and the director is 5% to 15% shorter than the half wave dipole antenna. The spacing between reflector and dipole is usually between 10 to 2.25 lambda .

ADVANTAGES:- The advantages of Yagi antenna are

1. It is very compact
2. Good unidirectional radiation pattern.
3. Good gain and beam width.

2.Discuss about Rhombic antenna with neat diagram and its advantages?

[2016]

Ans:- Rhombic antenna :- The rhombic antenna is a broad band directional antenna . A rhombic antenna consists of four wires, several wave lengths arranged in the form of rhombus, in a horizontal plan above earth surface supported by four poles at the corner .The plane figure is given in the figure. A terminating resistance R is used to prevent reflection. The radiation in from each is shown by main lobe .

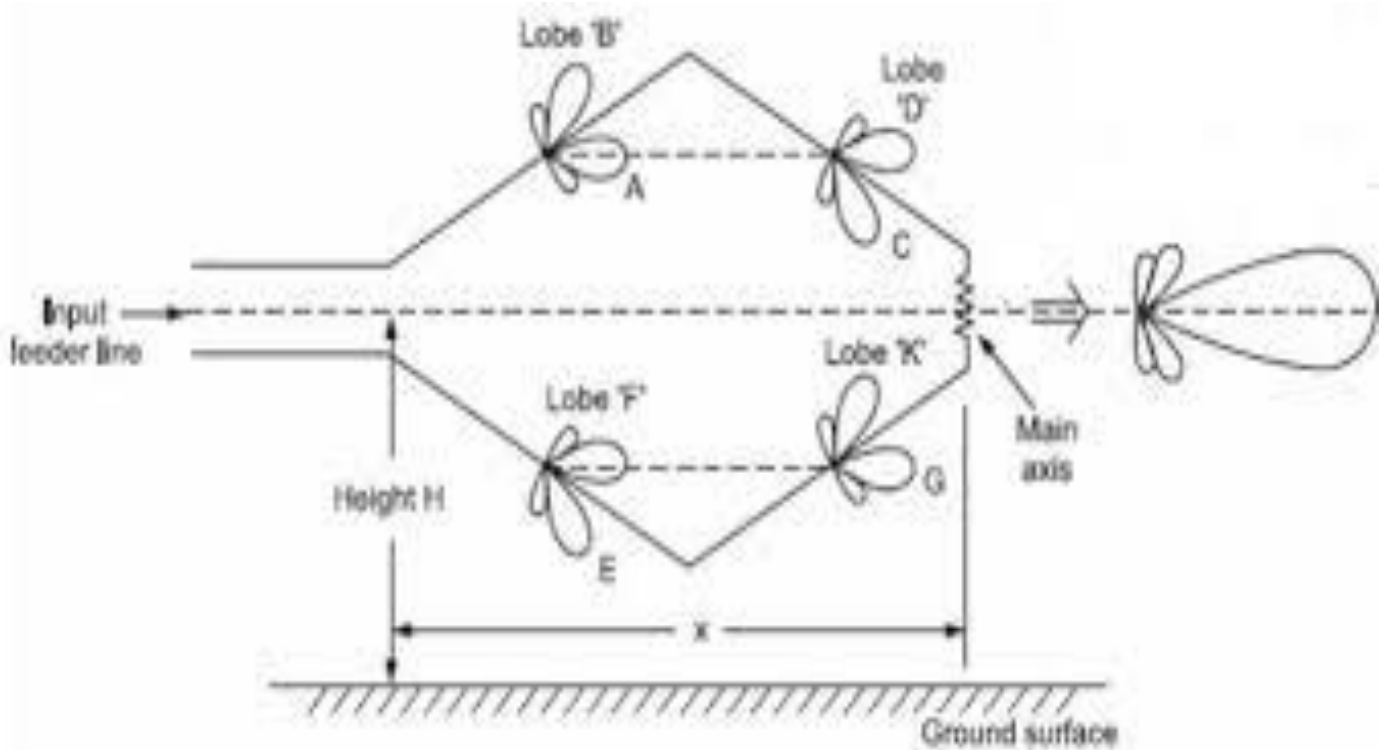

The length of the radiators vary from $2-8\lambda$ and the radiation angle θ varies from $40-75^\circ$. The four legs are considered as non resonant antenna. The transmission line feeds one end and transmit the unaffected current wave down each side towards the resistive termination at four end. The length of the sides and the angle θ are interrelated and must be carefully chosen, so that side lobe cancel properly and leaving only a single main lobe lying alone.

g the main axis of the rhombus.

ADVANTAGES:- The advantages of Rhombic antenna are

1. Low cost
2. Easy to maintain
3. Highly directional.
4. Constant input impedance for different frequency operation.etc

3.Discuss Radiation Mechanism of an antenna?

[2016]

Ans:- The Radiation Mechanism An intuitive understanding of the origins of radiation can be gained by associating radiation with the acceleration of charge. In fact, this notion can be mathematically proven from Maxwell's equations, but it is beyond the scope of what we wish to discuss here. Instead, if we accept that radiation is produced by the acceleration of charge, then consider the diagram shown in Figure 1.

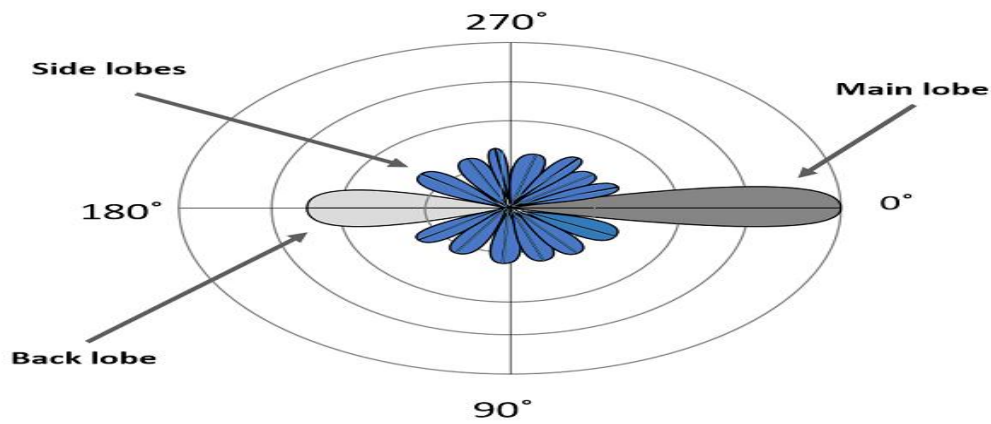
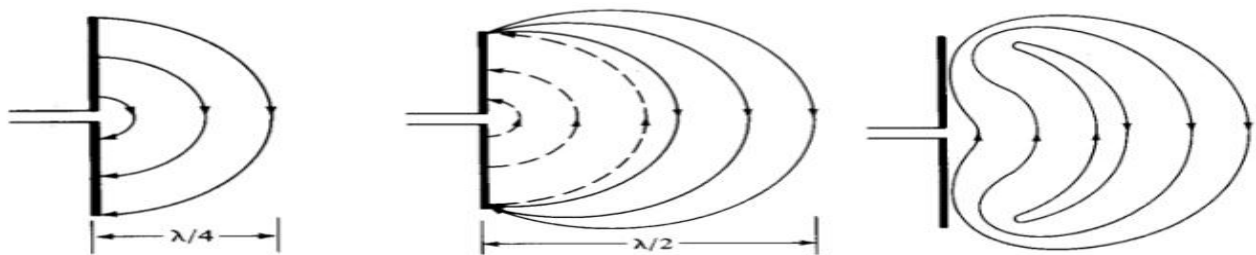

Figure 1: Accelerating charge Consider a point charge q in a vacuum moving at a constant, non-relativistic velocity $v < c$ along the z -axis (vertical direction) for $t < 0$. At $t = 0$, the point reaches the point A shown in the diagram. We can sketch radial field lines diverging away from the point charge at A, which are shown in the lines outside the largest circle shown in the diagram. At $t = 0$, the charge begins to accelerate until it reaches point B, at which point it resumes travelling at a constant (higher) velocity. The time interval between points A and B is denoted as Δt , and the distance travelled between those two points is Δz . The field lines produced by the point charge at B are sketched inside the innermost circle. Since we associate charge acceleration with radiation, then if the two circles represent wave fronts then the difference in their radii must be $\Delta r = r_A - r_B = c\Delta t$ (1) since the propagation velocity of a wave in a vacuum is the speed of light c . Notice that the difference in radii is shown to be larger than Δz . This is consistent, since the speed of the charge v was assumed to be much smaller than the speed of light. In fact, the diagram has been purposefully exaggerated for clarity when in fact, $\Delta z \ll \Delta r$. Electric field lines must be continuous. If we now join the field lines produced by the charges at the two points, we see that they are generally discontinuous. This discontinuous or disturbed field structure is radiation. Interestingly, we see the field structure is not disturbed along the direction of the charge velocity. Conversely, normal to that direction, there seems to be the most radiation with the disturbed field having both a radial component E_r and a transverse component E_t . We will see later in the course that the transverse component persists far away from the antenna, and also that linear antennas (with charges confined to a line) do not radiate along their axes. Hence, an antenna can be thought of any structure that facilitates the acceleration and deceleration of charge in a way that promotes radiation. Truncated wires are good examples of such structures because charges must decelerate to have zero velocity at the ends of the wire. We will explore a variety of antenna structures in this course

RADIATION MECHANISM



4.State and Explain antenna gain, Directive gain, Directivity, Efficiency of an antenna, and Effective Aperture? [2016/2017/2019]

Ans:- **Antenna Gain**:- The term antenna gain describes how much power is transmitted in the direction of peak radiation to that of an isotropic source.

Directive Gain:- It is define in a particular direction as the ratio of the power density that would be radiated by an isotropic antenna . The directive gain of an isotropic antenna is unity.

Directivity:-The maximum directive gain of an antenna is called directivity. It is the ratio between maximum radiation intensity to the average radiation intensity.

Effective aperture:-The parameter which calculate the receiving power of an antenna is effective aperture .Lets assume that a plane wave same polarization as the received antenna is incident upon the antenna Suppose the wave is travelling towards the antenna in the antennas direction of maximum radiation. Then the effective aperture describes how much power is captured from a given plane wave.

Antenna Efficiency:-It is the ratio of radiated power to the input power of an antenna.

Mathematically

$$\text{Efficiency } (\eta) = P_{\text{rad}} / P_{\text{in}}$$

$$\text{Further } P_{\text{in}} = P_{\text{d}} + P_{\text{rad}}$$

Where P_{rad} = Power Actually Radiated

P_{d} = Power lost or dissipated

$$\text{Therefore, } \eta = \{P_{\text{rad}} / (P_{\text{rad}} + P_{\text{d}})\} * 100$$

4.Discuss about parabolic antenna with advantages , disadvantages and application ? [2016]

Ans:- **Parabolic Antenna** :- It is a very high gain narrow beam width used in UHF range. A parabolic antenna consists of two main parts.

- (I) A parabolic reflector
- (II) Feed mechanism (Active Element)

The feed mechanism houses the the primary antenna which radiates electromagnetic energy towards the reflector. The radiator is a passive device that simply reflects the energy radiated by active element housed in feed mechanism into a concentrated and highly directional pattern. The shape of a parabolic reflector are like a dish so it is called dish antenna .The basic concept is given in figure.

The feed point is placed at the focal point of the dish and the electromagnetic energy is radiated from the feed point with spherical wave front and is directed onto the dish. The geometry of dish is such that the distance from the focal point to the dish and then to the arbitrary plane X on the other side of the focal point is a constant.

$$\text{Thus } \text{distance}=\text{RAX}=\text{distance}=\text{RBX}=\text{RCX}=\text{RDX}=\text{RFX}$$

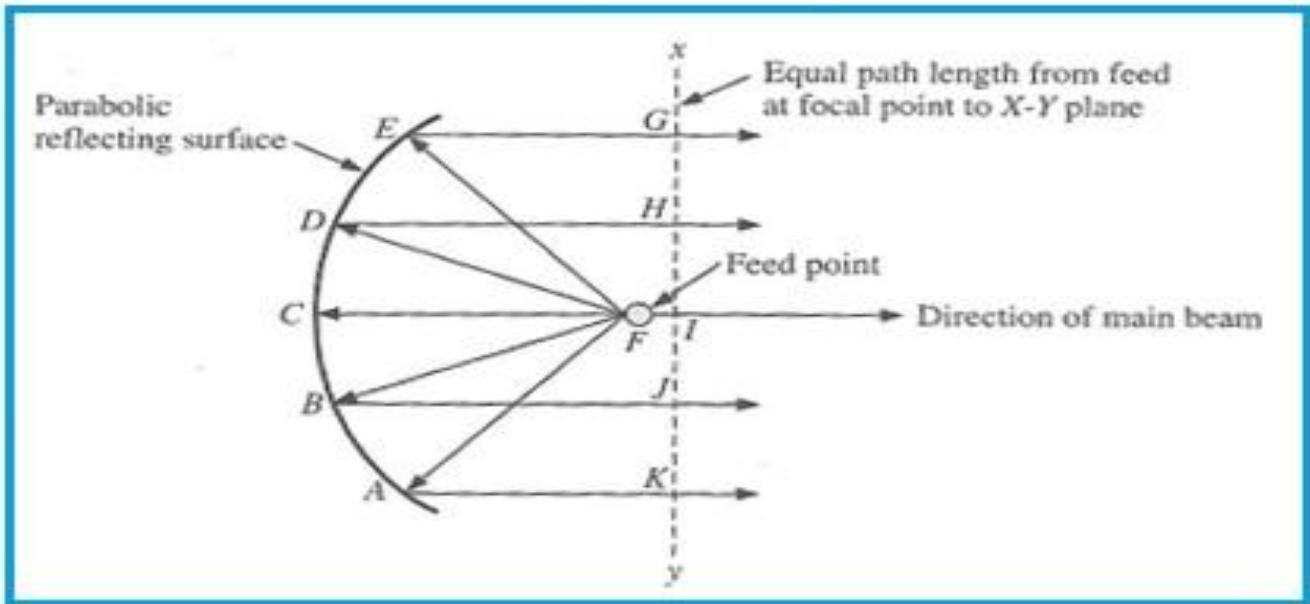

The spiral wave front produced by the feed is converted into a plane wave front at plane X. The reflected wave are all parallel with one another and form a highly directive electromagnetic wave.

$$\text{The effective aperture } A_e = \pi (D^2/4)$$

Where $D =$ Diameter of dish

$$\text{Gain of the antenna with isotropic radiation} = \pi^2 D^2 / \lambda^2$$

$$\text{Relative to } \lambda/2 \text{ dipole } G = K(D/\lambda)^2$$

ADVANTAGES:-

1. It has high directivity
2. Narrow beam width
3. It can be used as both transmitting and receiving antenna.
4. Smaller in size and low cost

DISADVANTAGES:-

1. Complex in Design
2. Surface distortion can occur in very large dish.
3. Proper adjustment must be needed in order to get proper signal

APPLICATION:-

It is used for satellite communication and other communication .

CHAPTER-3

2 marks questions

1. Define Standing Wave Ratio ?

[2016]

Ans:- **SWR** :- Standing Wave Ratio is used to measure the mismatch between source and load. To describe the characteristics of voltage distribute on transmission line a quantity is known as SWR is usually may be define as the ratio of maximum voltage or maximum current to the minimum current.

Mathematically,

$$SWR = V_{\max} / V_{\min} \quad \text{OR} \quad I_{\max} / I_{\min}$$

2. What is Stub, and single stub matching ?

[2016
,2019]

Ans:- **Stub**:- A Relative short length of transmission line is used for impedance matching. This stub act as a reactance and is placed in parallel with transmission line. The connecting section of open or short circuited line in shunt with the main line at a certain point to effect the mismatching impedance is called stub.

Single Stub Matching:- Impedance matching can be obtained by incerting another transmission line . In single stub technique if load is changes then the location of insertion may have to be moved . Generally shorted stub are used because it radiate less energy. Since the circuit is based on insertion of a parallel stub is more convenience to work with admittance.

3. State the relation between SWR and Reflection coefficient ?

[2016/2019]

Ans:- **VSWR** :- VSWR is related to the reflection coefficient. A higher ratio depicts a larger mismatch, while 1:1 ratio is perfectly matched. This match or mismatch arises from the standing wave's maximum and minimum amplitude. SWR is related to the ratio between transmitted and reflected energy.

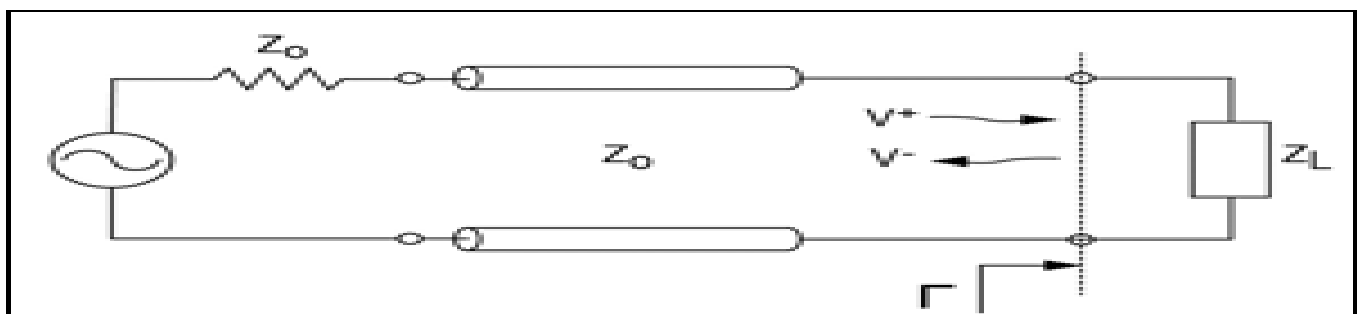

Long Questions (5marks & 7 marks)

1. Discuss different types of losses in Transmission line?

[2016/2017]

Ans:- There are three main losses in transmission line-

- (a) Conductor Loss
- (b) Dielectric Loss
- (c) Radiation Loss

Conductor Loss-

This loss occurs due to finite resistance of T_x line. When current flows through a T_x line the energy is despite de form of I^2R A reduction in resistance will decrease the power loss in the line. The resistance is directly proportional to the cross sectional area. Keeping the line as short as possible will decrease resistance and I^2R loss . At high frequency the I^2R losses is mainly due to skin effect. When DC signal is applied the moment of electron through its cross section is uniform. When AC signal is applied the alternating magnetic flux within the conductor induces an emf .This emf causes current density to decrease in the interior of the wire and to increase towards the outer surface. This is known as skin effect .The flux density at the center is so great that the electron movement at this point is decreased.

Dielectric Loss-

Dielectric loss comes from the leakage current which flows through the dielectric of the coaxial cable. Dielectric losses are proportional to the voltage across the dielectric and increase with frequency. These losses are less when air dielectric are used . If losses are to be minimized an insulation with a low dielectric constant is used.

Radiation Loss-

Radiation losses results from loss of when the coaxial cable can not restrain all of the signal energy to stay within the shield .Radiation losses can be minimized by terminating the line with a resistive load equal to line characteristics impedance and by proper shielding . Proper shielding can be done by using coaxial cable with outer conductor grounded . The problem of radiation loss is of consequence only for parallel line transmission line .Radiation loss are difficult to estimate.

Standing wave-

When a signal is applied to a T_x line voltage and current will appear and this value of voltage and current depends on characteristics impedance of the T_x line. If characteristics impedance $Z_0 = Z_L$ then no power is reflected When characteristics impedance $Z_0 \neq Z_L$ then some of the power is reflected so an interference is set up between the travelling wave and reflected wave , which is known as Standing wave.

1. With neat Diagram Explain about Primary constant of Transmission line?

[2017]

Ans:- **Primary Constant of Transmission Line :-** The primary line constants are parameters that describe the characteristics of conductive transmission lines, such as pairs of **copper** wires, in terms of the physical electrical properties of the line. The primary line constants are only relevant to transmission lines and are to be contrasted with the **secondary line constants**, which can be derived from them, and are more generally applicable. The secondary line constants can be used, for instance, to compare the characteristics of a **waveguide** to a copper line, whereas the primary constants have no meaning for a waveguide.

The constants are conductor resistance and inductance, and insulator capacitance and conductance, which are by convention given the symbols R , L , C , and G respectively. The constants are enumerated in terms of per unit length. The circuit representation of these elements requires a **distributed element model** and consequently **calculus** must be used to analyse the circuit. The analysis yields a system of two first order,

simultaneous linear **partial differential equations** which may be combined to derive the secondary constants of **characteristic impedance** and **propagation constant**.

A number of special cases have particularly simple solutions and important practical applications. Low loss cable requires only L and C to be included in the analysis, useful for short lengths of cable. Low frequency applications, such as pair telephone lines, are dominated by R and C only. High frequency applications, such as **RF co-axial cable**, are dominated by L and C . Lines **loaded** to prevent distortion need all four elements in the analysis, but have a simple, elegant solution.

Circuit representation

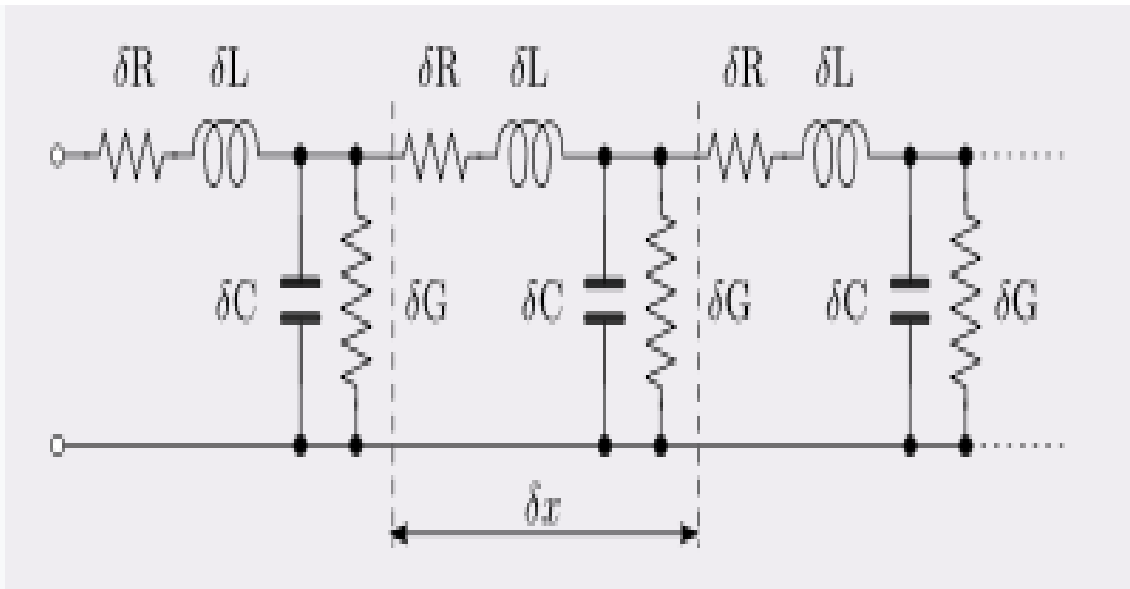

Equivalent circuit representation of a transmission line using distributed elements. δL , δR , δC and δG are to be read as, $L\delta x$, $R\delta x$, $C\delta x$ and $G\delta x$ respectively

The line constants cannot be simply represented as **lumped elements** in a circuit; they must be described as **distributed elements**. For instance "pieces" of the capacitance are in between "pieces" of the resistance. However many pieces the R and C are broken into, it can always be argued they should be broken apart further to properly represent the circuit, and after each division the number of **meshes** in the circuit is increased. This is shown diagrammatically in figure 1. To give a true representation of the circuit, the elements must be made **infinitesimally** small so that each element is distributed along the line.

2. With neat Diagram Explain about Secondary constant of Transmission line?

[2017]

Ans:-Secondary Constant of Transmission Line :-The primary line constants are only relevant to transmission lines and are to be contrasted with the **secondary line constants**, which can be derived from them, and are more generally applicable. The secondary line constants can be used, for instance, to compare the characteristics of a **waveguide** to a copper line, whereas the primary constants have no meaning for a waveguide.

The constants are conductor resistance and inductance, and insulator capacitance and conductance, which are by convention given the symbols R , L , C , and G respectively. The constants are enumerated in terms of per unit length. The circuit representation of these elements requires a **distributed element model** and consequently **calculus** must be used to analyze the circuit. The analysis yields a system of two first order, simultaneous linear **partial differential equations** which may be combined to derive the secondary constants of **characteristic impedance** and **propagation constant**.

A number of special cases have particularly simple solutions and important practical applications. Low loss cable requires only L and C to be included in the analysis, useful for short lengths of cable. Low frequency applications, such as pair telephone lines, are dominated by R and C only. High frequency applications, such

as **RF co-axial cable**, are dominated by *Land C*. Lines **loaded** to prevent distortion need all four elements in the analysis, but have a simple, elegant solution.

R and *L* are elements in series with the line (because they are properties of the conductor) and *C* and *G* are elements shunting the line (because they are properties of the dielectric material between the conductors). *G* represents leakage current through the dielectric and in most cables is very small. The word *loop* is used to emphasize that the resistance and inductance of both conductors must be taken into account. For instance, if a line consists of two identical wires that have a resistance of 25 mΩ/m each, the *loop* resistance is double that, 50 mΩ/m. Because the values of the constants are quite small, it is common for manufacturers to quote them per kilometer rather than per metre; in the English-speaking world "per mile" can also be used.^{[1][2]}

The word "constant" can be misleading. It means that they are material constants; but they may vary with frequency. In particular, *R* is heavily influenced by the **skin effect**. Furthermore, while *G* has virtually no effect at **audio frequency**, it can cause noticeable losses at high frequency with many of the **dielectric** materials used in cables due to a high **loss tangent**. Avoiding the losses caused by *G* is the reason many cables designed for use at **UHF** are air-insulated or foam-insulated (which makes them virtually air-insulated).^[3] The actual meaning of constant in this context is that the parameter is constant with *distance*. That is the line is assumed to be homogenous lengthwise. This condition is true for the vast majority of transmission lines in use today.^[4]

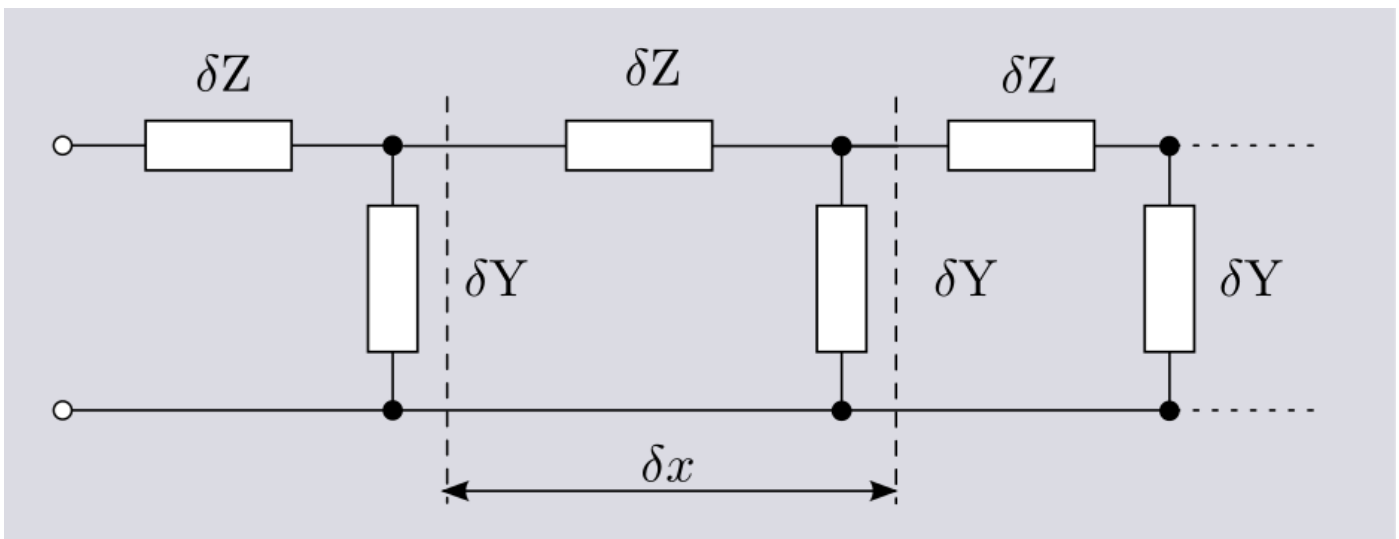

It is convenient for the purposes of analysis to roll up these elements into general series **impedance**, *Z*, and shunt **admittance**, *Y*.

2. Write Short notes on Incident wave ,Reflected Wave and Standing Wave ?

[2017]

Ans:- Incident Wave :-An incident wave is a current or voltage wave that travels through a transmission line from the generating source towards the load. It becomes incident when it arrives at a discontinuity or another medium with different propagation characteristics. At this point, some or all of the wave will be reflected back in the opposite direction to the original. Reflections will also occur at the end of the transmission line unless it is correctly terminated with its characteristic impedance. This situation occurs in practice when, for example, two lengths of dissimilar transmission lines are joined together.

These characteristics apply to electrically conducting transmission lines, often called copper lines as generally found in telecommunications circuits. However, the same wave behavior occurs in other metals, particularly aluminum as used in power lines. Additionally, waves in fiber-optic lines and microwave reflections in waveguides perform in essentially the same way.

Reflections cause several undesirable effects, including modifying frequency responses, causing overload power in transmitters and over voltages on power lines. However they can also be used in devices like stubs and impedance transformers. The reflections cause standing waves to be set up on the line, which are used by stubs. Their reactive properties are determined by their physical length in relation to the wavelength of the propagated waves. Therefore, stubs are most commonly used in UHF or microwave circuits whose short wavelengths allow them to be conveniently small. They are often used to replace discrete capacitors and inductors, because at UHF and microwave frequencies lumped components perform poorly due to parasitic reactance.

Reflected wave :- Reflection is the change in direction of a **wave front** at an **interface** between two different **media** so that the wave front returns into the medium from which it originated. Common examples include the reflection of **light**, **sound** and **water waves**. The *law of reflection* says that for **secular reflection** the angle at which the wave is incident on the surface equals the angle at which it is reflected. **Mirrors** exhibit secular reflection.

In **acoustics**, reflection causes **echoes** and is used in **sonar**. In geology, it is important in the study of **seismic waves**. Reflection is observed with **surface waves** in bodies of water. Reflection is observed with many types of **electromagnetic wave**, besides **visible light**. Reflection of **VHF** and higher frequencies is important for **radio** transmission and for **radar**. Even **hard X-rays** and **gamma rays** can be reflected at shallow angles with special "grazing" mirrors.

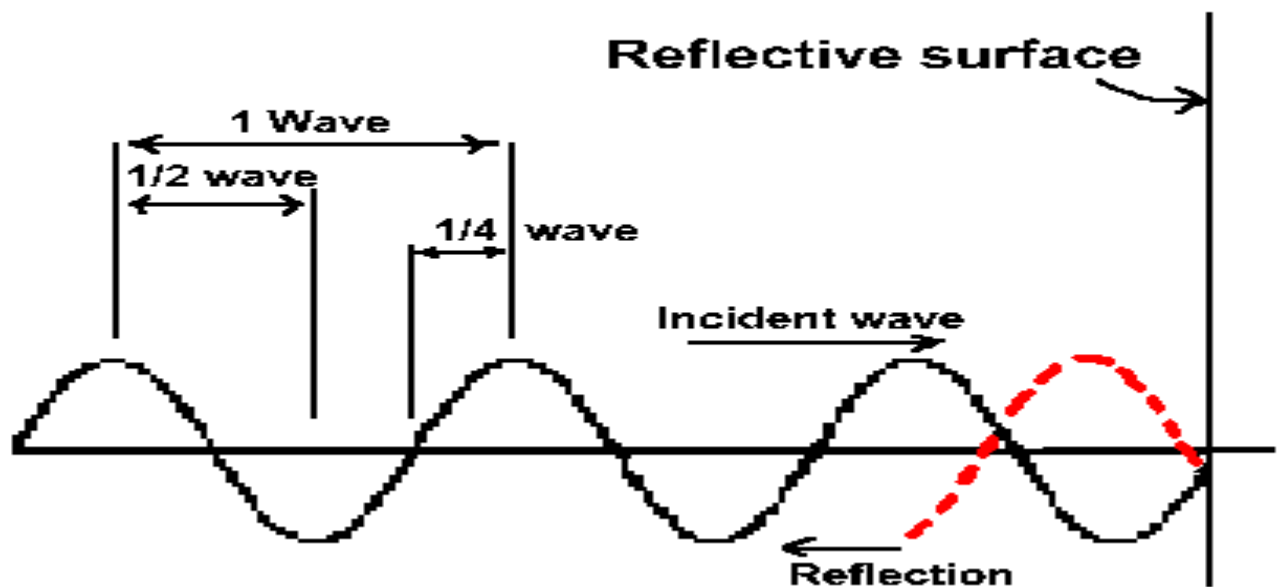

Standing wave

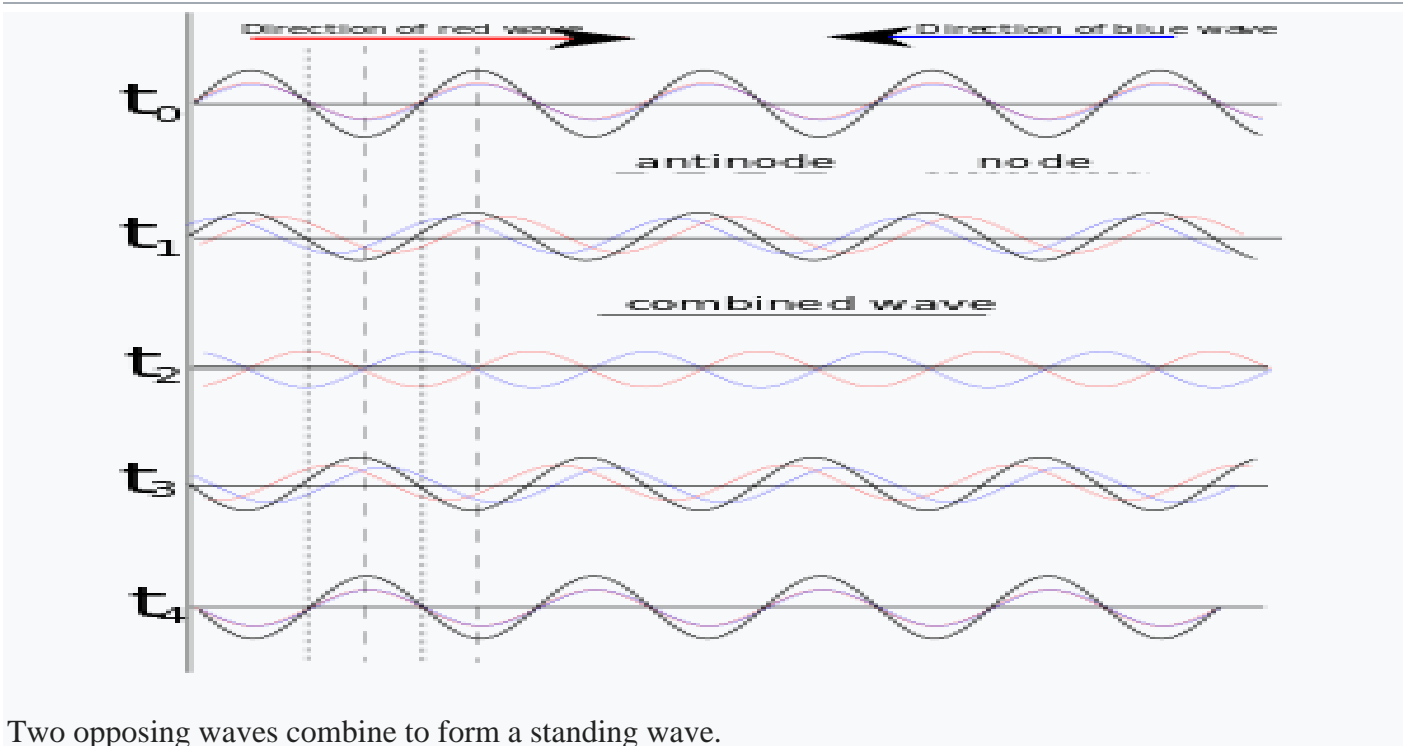

Two opposing waves combine to form a standing wave.

A standing wave – also known as a stationary wave – is a **wave** which oscillates in time but whose peak amplitude profile does not move in space. The peak **amplitude** of the wave oscillations at any point in space is constant with time, and the oscillations at different points throughout the wave are **in phase**. The locations at which the amplitude is minimum are called **nodes**, and the locations where the amplitude is maximum are called **antinodes**.

This phenomenon can occur because the medium is moving in the opposite direction to the wave, or it can arise in a stationary medium as a result of **interference** between two waves traveling in opposite directions. The most common cause of standing waves is the phenomenon of **resonance**, in which standing waves occur inside a **resonator** due to interference between waves reflected back and forth at the resonator's **resonant frequency**.

For waves of equal **amplitude** traveling in opposing directions, there is on **average** no net **propagation of energy**.

3. Write Short notes on Stub matching ?

[2017]

Ans:-**Stub matching :-**

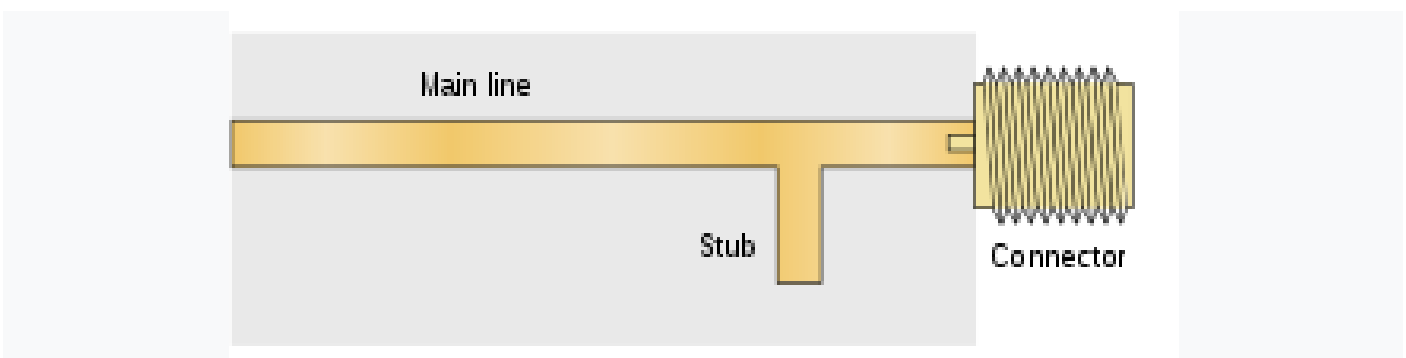

In a strip line circuit, a stub may be placed just before an output connector to compensate for small mismatches due to the device's output load or the connector itself.

Stubs can be used to match a load impedance to the transmission line characteristic impedance. The stub is positioned a distance from the load. This distance is chosen so that at that point the resistive part of the load impedance is made equal to the resistive part of the characteristic impedance by **impedance transformer action** of the length of the main line. The length of the stub is chosen so that it exactly cancels the reactive part of the presented impedance. That is, the stub is made capacitive or inductive according to whether the main line is presenting an inductive or capacitive impedance respectively. This is not the same as the actual impedance of the load since the reactive part of the load impedance will be subject to impedance transformer action as well as the resistive part. Matching stubs can be made adjustable so that matching can be corrected on test.

A single stub will only achieve a perfect match at one specific frequency. For wideband matching several stubs may be used spaced along the main transmission line. The resulting structure is filter-like and filter design techniques are applied. For instance, the matching network may be designed as a **Chebyshev filter** but is optimized for impedance matching instead of pass band transmission. The resulting transmission function of the network has a pass band **ripple** like the Chebyshev filter, but the ripples never reach 0 dB insertion loss at any point in the pass band, as they would do for the standard filter.

CHAPTER-4

2 marks questions

1.What do you mean by Aspect Ratio and why it is essential in colour TV ?

[

2016/2019]

Ans:-**Aspect Ratio** :- The ratio of width to height of the picture frame in a TV is called Aspect Ratio. The picture have a rectangular format with aspect ratio (Width to Height)= 4:3.

If the aspect ratio is not maintained then the image in the screen either thin or too broad so aspect ratio must maintain.

2.What is resolution and what are the types of resolution ?

[2016]

Ans:- **Resolution** :-The ability of image reproducing system to represent the fine structure of an object is known as resolution.

It is necessary to consider this aspect separately in the horizontal and vertical plane of the picture . This depends upon the number of scaling lines used for frame.

Types of Resolution :- There are following types of resolution

- 1.Pixel resolution
- 2.Spatial resolution
- 3.Spectral resolution
- 4.Temporal resolution
- 5.Radiometric resolution

3. What do you mean by Aspect Ratio , Flicker Luminance , Hue and Saturation ?

[2016]

Ans:-**Aspect Ratio** :- The ratio of width to height of the picture frame in a TV is called Aspect Ratio. The picture have a rectangular format with aspect ratio (Width to Height)= 4:3.

Flicker :-The rate of 24 picture per second in motion picture and scanning of 25 frames per second in TV picture is enough to cause an illusion of continuity. They are not rapid enough to allow the brightness of one . Picture or frame to blocked smoothly into the next through the time when the screen is blanked between successive frames which results in a definite flicker of light that is very annoying to the observer when the screen made alternately bright and dark.

Luminance:- It is a **photometric** measure of the **luminous intensity** per unit area of **light** travelling in a given direction. It describes the amount of light that passes through, is emitted or reflected from a particular area, and falls within a given **solid angle**. The **SI** unit for luminance is **candela per square meter** (cd/m^2). A non-SI term for the same unit is the **nit**. The **CGS** unit of luminance is the **stills**, which is equal to one candela per square centimeter or 10 kcd/m^2 .

Saturation:-

The saturation of a color is determined by a combination of light intensity and how much it is distributed across the spectrum of different wavelengths. The purest (most saturated) color is achieved by using just one wavelength at a high intensity, such as in laser light. If the intensity drops, then as a result the saturation drops. To desaturate a color of given intensity in a **subtractive** system (such as **watercolor**), one can add white, black, **gray**, or the hue's **complement**.

Hue :- It is one of the main properties (called **color appearance parameters**) of a **color**, defined technically (in the **CIECAM02** model), as "the degree to which a stimulus can be described as similar to or different from stimuli that are described as **red, green, blue, and yellow**" (which in certain theories of color vision are called **unique hues**). Hue can typically be represented quantitatively by a single number, often corresponding to an angular position around a central or neutral point or axis on a color space coordinate diagram (such as a **chromaticity diagram**) or **color wheel**, or by its **dominant wavelength** or that of its **complementary color**. The other color appearance parameters are **colorfulness, saturation** (also known as intensity or chromo) **lightness**, and **brightness**.

Long Questions (5marks & 7 marks)

3. Describe Monochrome TV Receiver with block Diagram ?

[2017/2019]

Ans :- **Monochrome TV receiver** :-The monochrome TV receiver has the following blocks

Basic monochrome television receiver

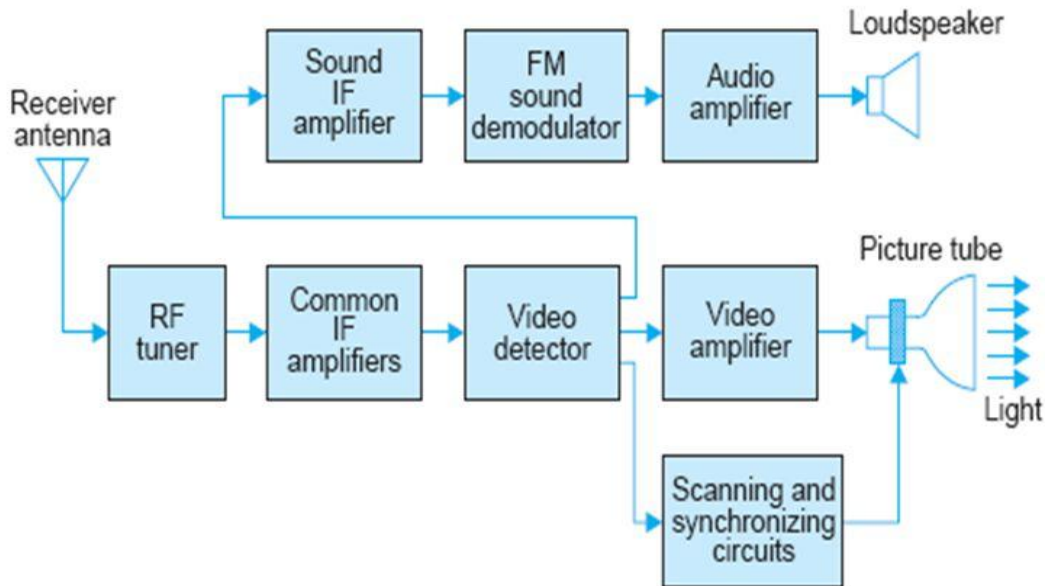

4

1. **TV Receiving Aerial:** The TV signal radiated by the transmitter has to be intercepted. For this an antenna with high gain, Broad Band, highly directional is used. Yagi-uda multi-element array is preferred. Impedance of the aerial should match the impedance of the transmission line. The aerial also selects the required signal and rejects unwanted signals.

2. **Tuner:** Also called RF Tuner/ Front end. Signals from Aerial are amplified, down converted to intermediate frequency. Band and channel selection is also carried out here. This is a separate, sealed and riveted unit mounted away from other circuits. Unit's body is grounded to avoid interference by other strong signals. Delayed AGC is used at RF amplifier.

3. **VIF Amplifier:** The output of RF Tuner has two intermediate frequencies i.e. video IF (38.9 MHz) and sound IF (33.5 MHz), occupying a band width of 7 MHz. Most of the amplification and selection is done here. This is also a separate, enclosed unit. Keyed AGC is used at the base of 1st IF Amplifier.

4. **Video Detector:** The output of VIF section is around 2 to 5VPP. This is fed to video detector to separate various signals i.e., video, AGC, inter carrier SIF. A special diode driven into saturation has many harmonics at its output. Using LPF, signals above 5 MHz are filtered out. OA 79, Ge, heavily doped, point contact diode is used for detection.

5. **Video Output Amplifier:** Output of video detector which is around 2 to 5 VPP is amplified by a single stage broad band, voltage amplifier to give an output of 80 VPP. Wave Trap is used to prevent 5.5 MHz inter – carrier SIF (38.9 – 33.4 MHz = 5.5 MHz) and disturb the picture. Output of this amplifier is fed to picture tube.

6. **Picture Tube:** This is a special type of CRT, having widescreen with wide deflection angle.

Electromagnetic deflection and electro-static Focusing is used. H and V deflection coils moulded into a single unit 'Yoke' is mounted on the neck Final anode is applied with Extra high Tension (EHT) which is around 12 to 18 kV. Screen is formed by long persistence P4 phosphor, which is a mixture of cadmium tungstate and zinc sulphide. The light radiated is Yellowish white. With proper output from syn section, picture is displayed on the screen.

7. **Sync Section:** Output of video detector which is composite video signal has H and V sync pulses either at top or bottom edges. By feeding video signal to sync separator, sync pulses can be separated. We can use clipper circuit when the video signal is with negative sync. Further, by using LPF, V- sync can be separated. Using HPF, H sync pulses can be separated. These pulses are used to synchronize the H and V saw-tooth

oscillators. Output of these oscillators are amplified and used to drive the deflection coils on the picture tube.

8. **Inter Carrier SIF Section:** Output of detector has 5.5 MHz, which is the result of heterodyning between VIF and SIF (38.9 MHz – 33.4 MHz). This has frequency modulated Audio Signal. By using highly selective tuned circuit (sound-takeoff coil), 5.5 MHz is separated. This is amplified and frequency demodulated to recover Audio signal.

9. **Audio Section:** Output from SIF section which is weak AF signal is amplified both in terms of voltage and power to drive the loud speaker. Finally, we get sound output.

10. **Power Supply:** Various levels of DC voltages are required for the operation of TV receiver. So, 230 V, 1 ϕ AC is rectified, filtered and regulated to provide ripple free steady voltage to various stages. However due to many advantages switch mode power supplied (SMPS) are widely used now-a-days. EHT and BHT required at picture tube is obtained from Auxiliary power supply using Line output transformer (LOT/EHT).

2. Explain Rectangular scanning and Interlaced scanning ?

[2016/2019]

Ans :- **Rectangular Scanning** :-For rectangular picture frame rectilinear scanning is used . This rectilinear scanning involves two scanning simultaneously .

1. Horizontal Scanning
2. Vertical Scanning

In Horizontal Scanning the scanning spot starts at the upper left hand corner and moves from left to right along the shortest line at the uniform rate. But since there is simultaneously a relative slow vertical downward movement also , the spot reaches the right hand edge at a slightly lower point.

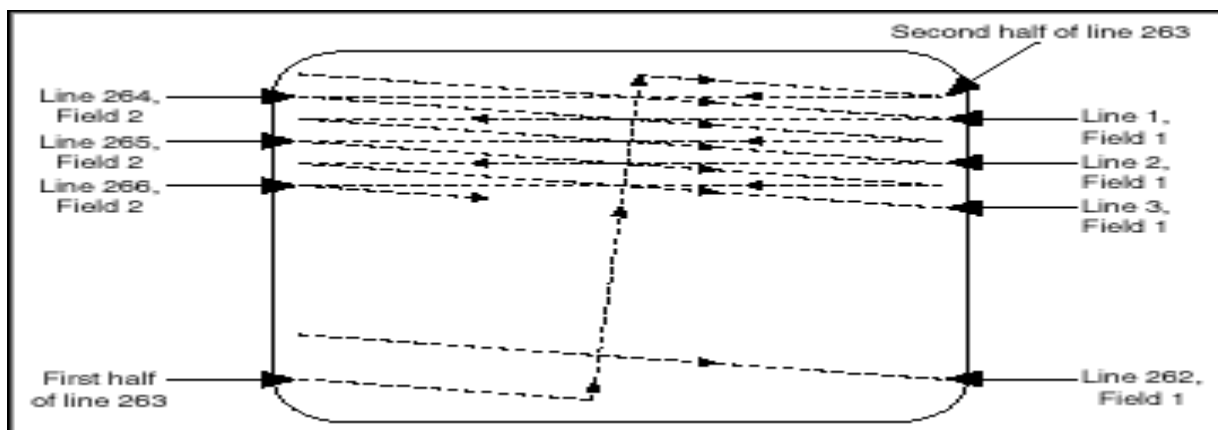

In the figure ab represents one such horizontal scanning line. When the end of the line ab is reached the horizontal scanning suddenly reversed and the scanning spot quickly return to left (From b to c). This point c almost same height as b since retrace is extremely quick . During the retrace from b to c the spot is blanked out .Hence retrace line is not visible .However it is shown in dotted .At the left hand point c forward horizontal scanning again begins producing a new scanning line cd . However the scanning point moves to and fro across the frame ,the spot also moved downward at a constant but slow rate . Hence the scanning lines are slightly sloped and each forward scanning line is a little below the preceding line. This continuous until the bottom of the picture is reached at h, the point at which only half of the horizontal scanning has completed . Now quick vertical upward fly back begins bringing the spot from h to i . The horizontal to and fro scanning however continue .

Interlaced Scanning :-

Interlaced Scanning

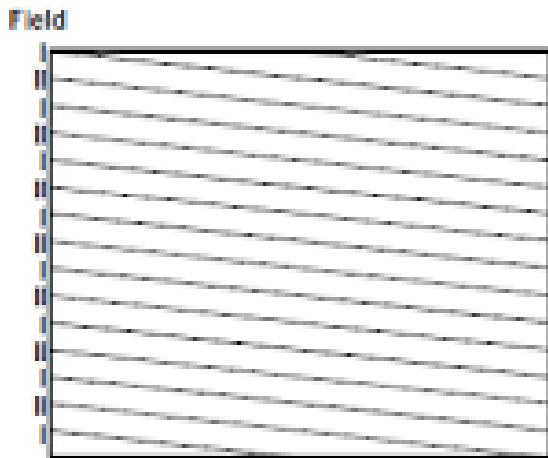

Non-Interlaced Scanning

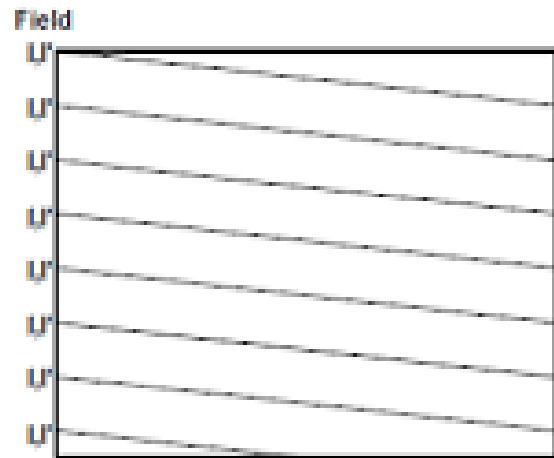

To avoid the interlaced scanning is used . In this types of scanning each frame is shown twice on the face of the picture tube . It scan the picture from left to right and top to bottom and the total numbers of lines are divided into two groups called field.

In interlaced scanning , the numbers of lines per picture must be odd.

3. Write short notes on

LCD, Interlaced scanning, Composite video signal ?

[2017]

Ans :- LCD :-

A *liquid-crystal display* (LCD) is a **flat-panel display** or other **electronically modulated optical device** that uses the light-modulating properties of **liquid crystals**. Liquid crystals do not emit light directly, instead using a **backlight** or **reflector** to produce images in color or **monochrome**.^[1] LCDs are available to display arbitrary images (as in a general-purpose computer display) or fixed images with low information content, which can be displayed or hidden, such as preset words, digits, and **seven-segment displays**, as in a **digital clock**. They use the same basic technology, except that arbitrary images are made up of a large number of small **pixels**, while other displays have larger elements.

LCDs are used in a wide range of applications including **LCD televisions**, **computer monitors**, **instrument panels**, **aircraft cockpit displays**, and indoor and outdoor signage. Small LCD screens are common in portable consumer devices such as **digital cameras**, **watches**, **calculators**, and **mobile telephones**, including **smart phones**. LCD screens are also used on **consumer electronics** products such as DVD players, video game devices and **clocks**. LCD screens have replaced heavy, bulky **cathode ray tube (CRT)** displays in nearly all applications. LCD screens are available in a wider range of screen sizes than CRT and **plasma displays**, with LCD screens available in sizes ranging from tiny **digital watches** to very large **television receivers**.

Since LCD screens do not use phosphors, they do not suffer **image burn-in** when a static image is displayed on a screen for a long time, *e.g.*, the table frame for an airline flight schedule on an indoor sign. LCDs are, however, susceptible to **image persistence**.^[2] The LCD screen is more energy-efficient and can be disposed of more safely than a CRT can. Its low electrical power consumption enables it to be used in **battery-powered electronic** equipment more efficiently than CRTs can be. By 2008, annual sales of televisions with LCD screens exceeded sales of CRT units worldwide, and the CRT became obsolete for most purposes.

Interlaced Scanning :-

Interlaced Scanning

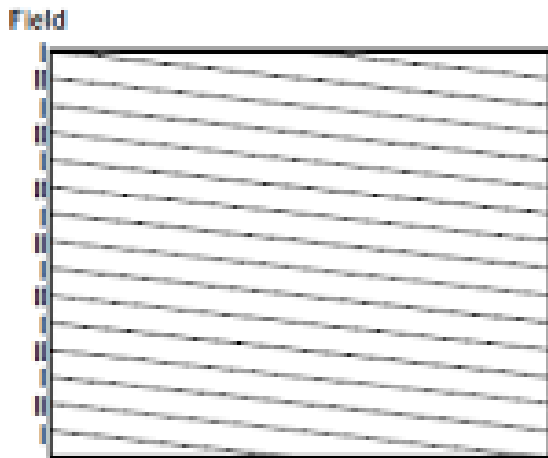

Non-Interlaced Scanning

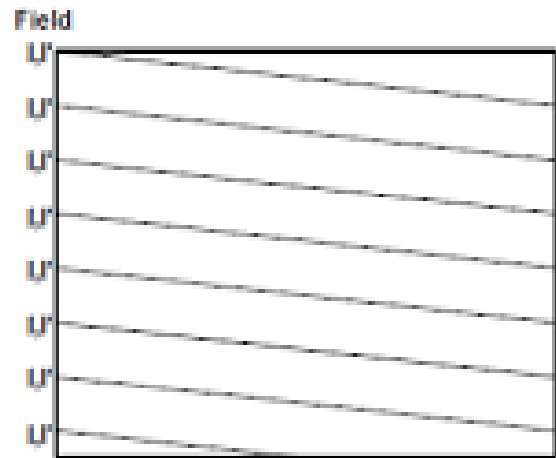

To avoid the interlaced scanning is used . In this types of scanning each frame is shown twice on the face of the picture tube . It scan the picture from left to right and top to bottom and the total numbers of lines are divided into two groups called field.

In interlaced scanning , the numbers of lines per picture must be odd.

Interlaced video is a technique for doubling the perceived frame rate of a video display without consuming extra **bandwidth**. The interlaced signal contains two **fields** of a video frame captured at two different times. This enhances motion perception to the viewer, and reduces **flicker** by taking advantage of the **phi phenomenon**.

This effectively doubles the time resolution (also called **temporal resolution**) as compared to non-interlaced footage (for frame rates equal to field rates). Interlaced signals require a display that is natively capable of showing the individual fields in a sequential order. **CRT displays** and **ALiS plasma displays** are made for displaying interlaced signals.

Interlaced scan refers to one of two common methods for "painting" a video image on an electronic display screen (the other being **progressive scan**) by scanning or displaying each line or row of pixels. This technique uses two fields to create a frame. One field contains all odd-numbered lines in the image; the other contains all even-numbered lines.

Composite Video Signal :-

The video signal is the electrical signal corresponding to the picture information at the output of the TV camera which seen the picture . To this video signal we add

1. Horizontal blanking pulse .
2. Horizontal synchronizing pulse .
3. Vertical Blanking pulse.
4. Vertical synchronizing pulse.
5. Equalizing pulse.

The resulting video signal is reffered as the composite video signal.

4. Draw the block diagram and working of SMPS of TV ?

[2016]

Ans :- **SMPS** :-SMPS (Switching Mode Power Supply) is also called Switching Regulator.

DC to AC =Constant DC

AC to AC =Frequency change

DC to AC = Inverter

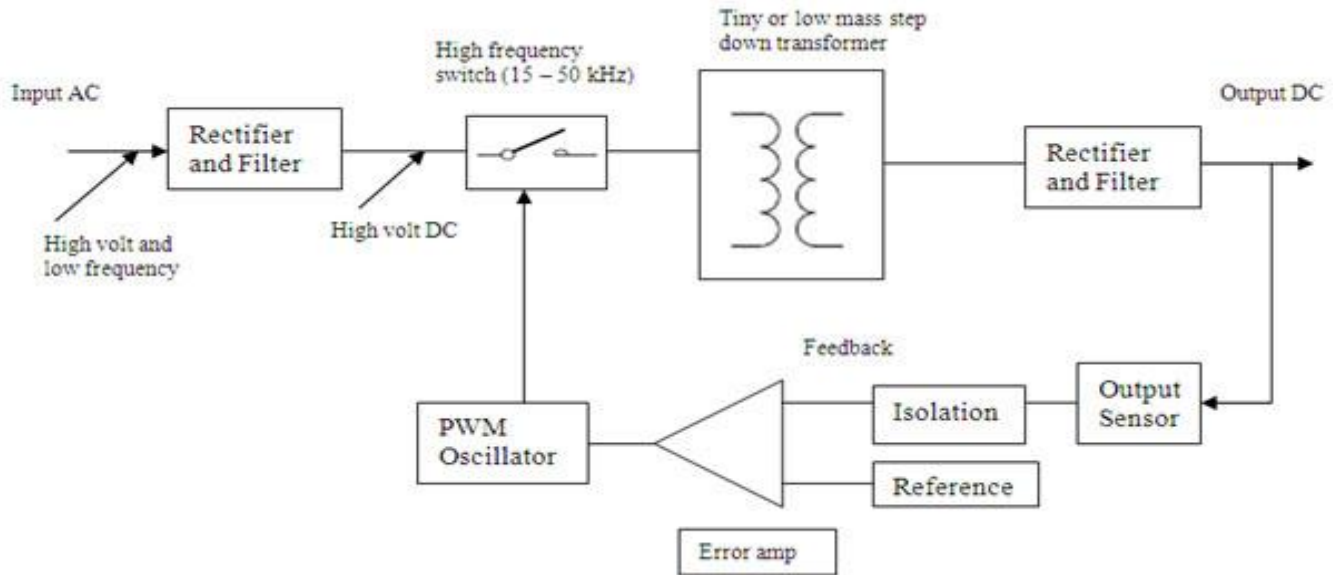

DC to DC and DC to AC convertor belongs to the category of SMPS. The switching regulator act as a continuously visible power convertor and hence its efficiency is always cutoff or in saturation mode.

The input dc supply is chopped at a higher frequency around 15 to 50 KHz using an active device BJT, MOSFET or SCR and the convertor transformer. The transformed wave is rectified and filtered. The oscillation allows the control element consists of a transistor switch ,an inductor and a diode . For each switched the energy is pumped into the magnetic field , associated with the inductor which is a transformer windings . Then this energy is released to the load at the desired voltage level.

CHAPTER-5

Long Questions (5marks & 7 marks)

1.Explain the working principle of two cavity klystron with neat diagram?

[2017/2019] Ans :-**Two Cavity Klystron** :-The two cavity amplifier klystron consists of the following.

1. Cathode
2. Focusing Electrode
3. Two bencher grids separated by a small distance forming a gap A .
4. Two catcher grids with a small gap B followed by a collector .

The input and output are taken from the tube via resonant cavity . The separation between bencher grids and catcher grid is called drift space. The electron beam passes the group-A in the bencher cavity to which RF signal is amplified and then allowed to drift freely without any influence from RF fields until it reaches the group-B at the output or catcher cavity. If all goes well oscillation will be excited in the second cavity which has of a power much higher than those in the bencher cavity so that large output can be achieved .

The electron beam after approaching at gap-A will be affected by the presence of RF voltage at point zero, electron passing the gap are unaffected and continue to the collector with some constant velocity.

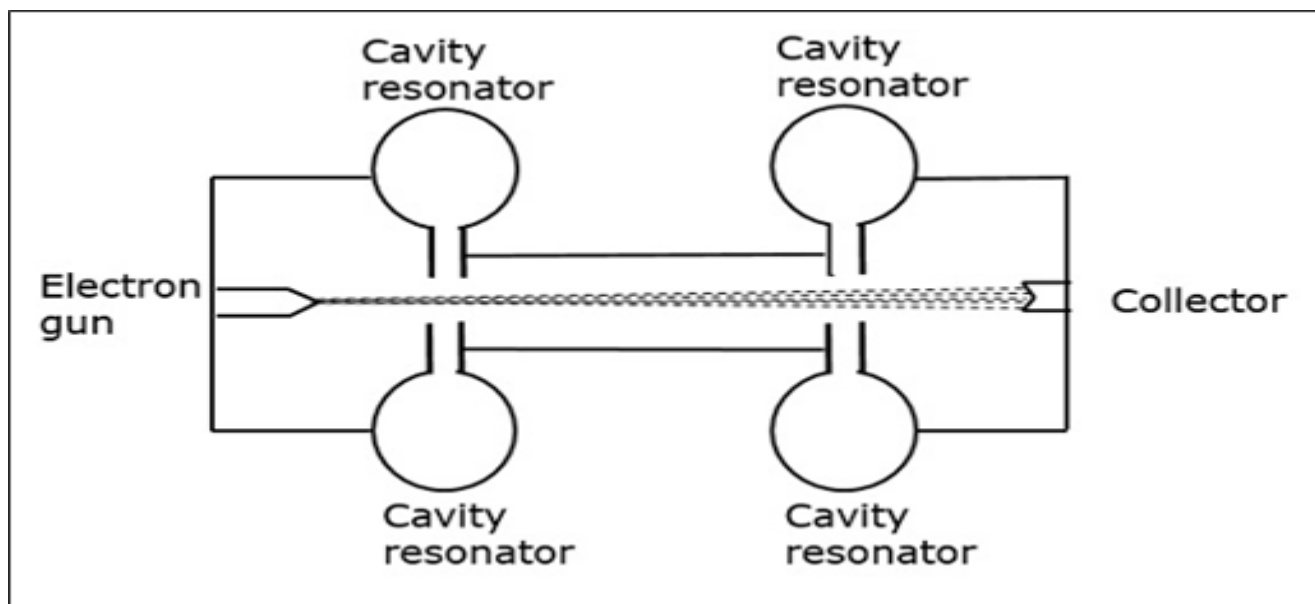

Let the reference electron Y, it is of course unaffected by the gap thus this is shown the same slope in the diagram. Another electron Z is slightly accelerated slightly by the positive voltage across the gap-A and it will catch up by the reference electron before gap-B is approached. Similarly electron X passes gap-A slightly before the reference electron and catch Y. Thus electron pass the bencher gap , they are velocity modulated by the RF voltage existing across the gap. .As the beam progresses further down the drift tube bunching becomes more conduct and as more as faster electors catch up with bunch ahead eventually current passes the catch gap in quite pronounced bunches and therefore varies cyclically with time. This variation in current density is known as current modulation.

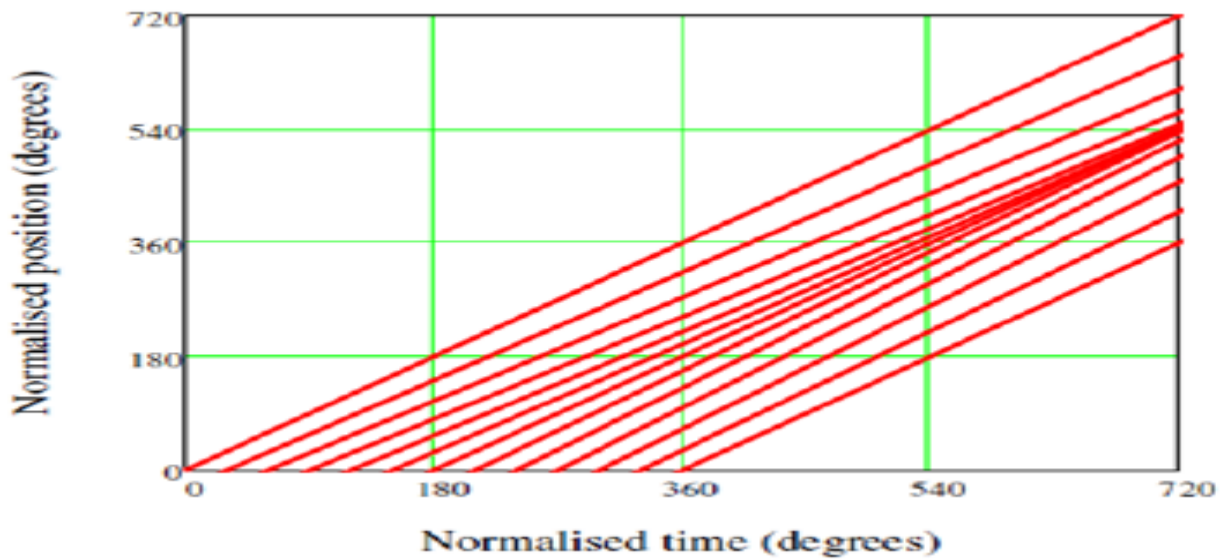
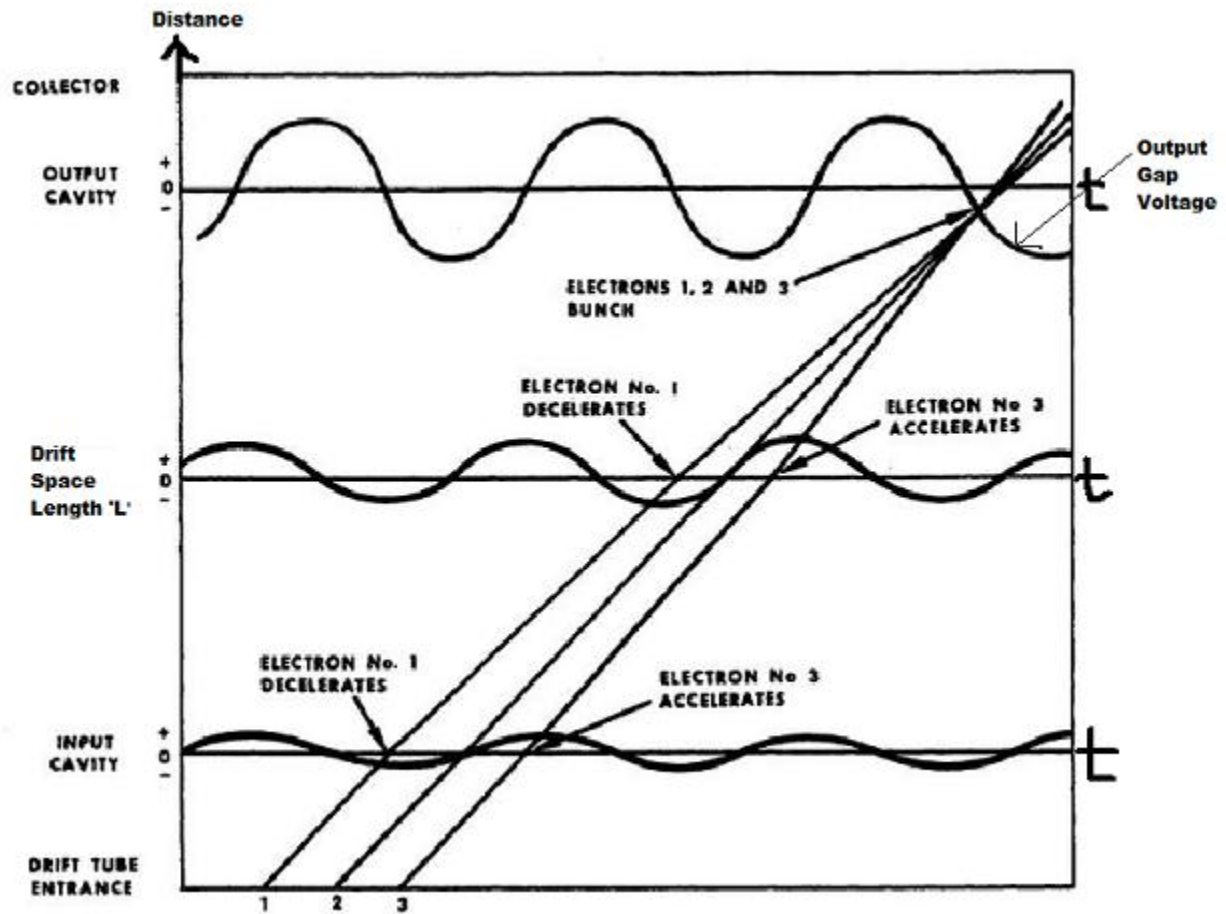

APPLICATION:-

1. Multicavity Power Amplifier
2. Two Cavity Power Oscillator

2. Explain the operation of Magnetron with neat diagram and write its application ?

[2016/2017/2019]

Ans :- **Magnetron** :- The magnetron is a self contained microwave oscillator where crossed electric and magnetic fields are used to produce the high power output that forms the basic of a microwave radar

transmitter system. All magnetron consists of some form of anode and cathode operated in a magnetic field that is normal to the electric field between the cathode and anode. The main component of all magnetron oscillators are cathode, anode, tank circuit and magnet. The three basic types of magnetron oscillators are identified on the basis of mechanism by means of which energy is transferred to the \rightarrow field.

1. **Negative Resistance magnetrons** :- Which make use of a static $-ve$ resistance present between two anode electrodes.

2. **Cyclotron Frequency Magnetron** :- Which depends upon synchronism between an alternating component of electric field and periodic oscillation of electrons in a direction parallel to this electric field.

3. **Travelling Wave Magnetron** :- Depends on interaction of moving electrons with a travelling electromagnetic field travelling with a constant linear or angular velocity. The simplex of klystron frequency magnetron is shown in the figure.

The diode formed by the anode cathode co-axial cylinders positioned between the poles of a permanent magnet and electromagnet so that the magnetic lines of force are parallel to the axis of the anode and cathode.

An electron transverse a magnetic field is acted upon by a force which depends on the magnitude of the electron velocity and the strength of magnetic field. The force exerted upon the electron is perpendicular to the direction of motion and magnetic field.

The magnetic field causes electron emitted from the cathode to moved in a curved path. In case the flux density of the magnetic field is sufficiently great the electrons do not strike the anode but return to the cathode and the anode current is cutoff.

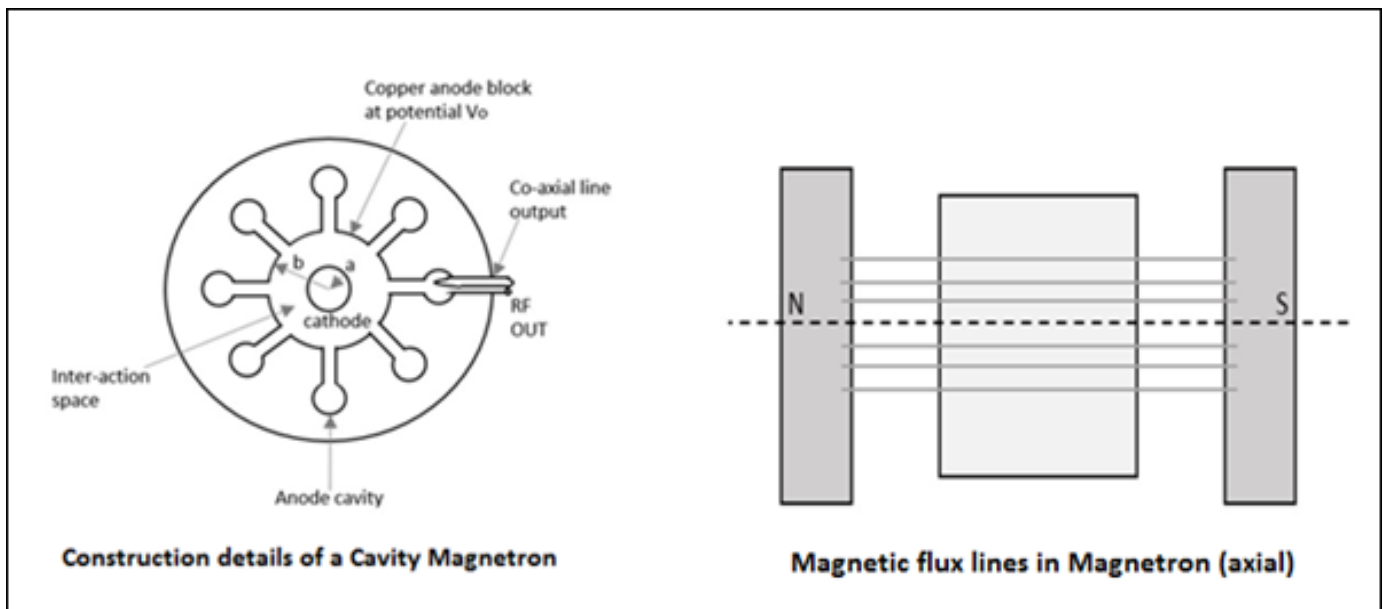

In travelling the cathode back the electrons are moving against dc field and are slowed down. The kinetic energy of electrons are transferred to anode via electronic field causing an variation in anode voltage which cause an alternating voltage and the tank circuit transfers energy to the load. The figure gives the detail constructional feature of a cavity magnetron with hole and slot structure.

Here the cylindrical cathode is surrounded by the anode with cavities and thus a radial dc electronic field is exists. The magnetic field is due to horse shoe type of magnet which produces coaxial magnetic field.

APPLICATION :-

1. Sweep oscillator
2. Missile application
3. Industrial heating
4. Microwave oven etc.

5.Explain the operation of Directional Coupler and Circulator ? [2016/2017]

Ans :- **Directional Coupler** :-A directional coupler is a four port wave guide junction . It is a four port passive device commonly used for coupling known fraction microwave to a port in the auxiliary line while following from the input port to the output port in mainline. The remaining port in an ideally isolated port and matched terminal.

It consists of a primary wave guide 1-2 and a secondary wave guide 3-4 . When all ports are terminated in their characteristics impedance there is a free transmission of power between port-1 and port-2 (without reflection) and there is no transmission of power between port-1 and port-3 or between port-2 and port-4 because no coupling exists between these two pair of ports . The amount of coupling between port-1 and port-4 and port-2 and port-3 depends on the structure of the coupler

The performance of a directional coupler is measured in terms of four basic parameters -Coupling (c), Directivity (D) , Transmission Loss (T), Return Loss (R). When all ports are matched these are defined as

$$\text{Coupling Factor (C) db} = 10 \log_{10} (P_1 / P_2)$$

$$\text{Directivity (D) db} = 10 \log_{10} (P_4 / P_3)$$

$$\text{Transmission Loss (T) db} = 10 \log_{10} (P_1 / P_4)$$

$$\text{Return Loss (R) db} = 10 \log_{10} (P_1 / P_3)$$

There are many types of directional coupler. Such as two hole directional coupler , four hole directional coupler .Two hole directional coupler consists of two piece of wave guide with one side common to both guides and two holes in the common side.

CIRCULATOR :-

A circulator is a multiport wave guide junction in which the wave can flow only from n^{th} port to $n+1$ port in one direction.

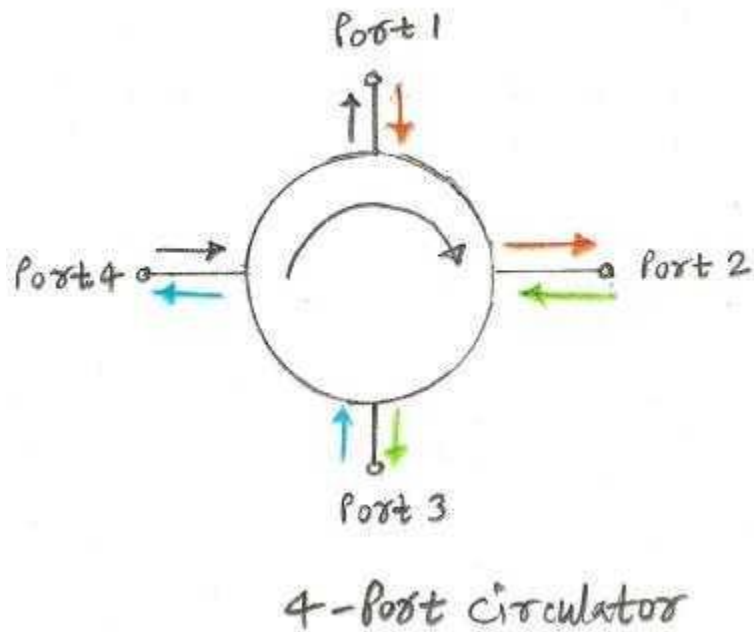

Circulator is a multiport wave guide junction in which the can travel from one port to next immediate port in one direction only. Commonly used circulator are three port or four port device although more number of port is possible. It has the property that each terminal is connected to the next clockwise terminal. Thus port-1 is connected to port-2 not to port-3 and 4. Port 2 is connected to port-3 but not port-4 and 1 and so on. A typical four port farad rotation circulator is shown in fig. The power input at port-1 is converted to the TE_{11} mode in the circulator wave guide , passes port -3 unaffected because the electric field significantly cut is rotated through 45° by the ferrite insert, continuous past port4 for the same reason that is passed through port-3 and finally emerges to port2.

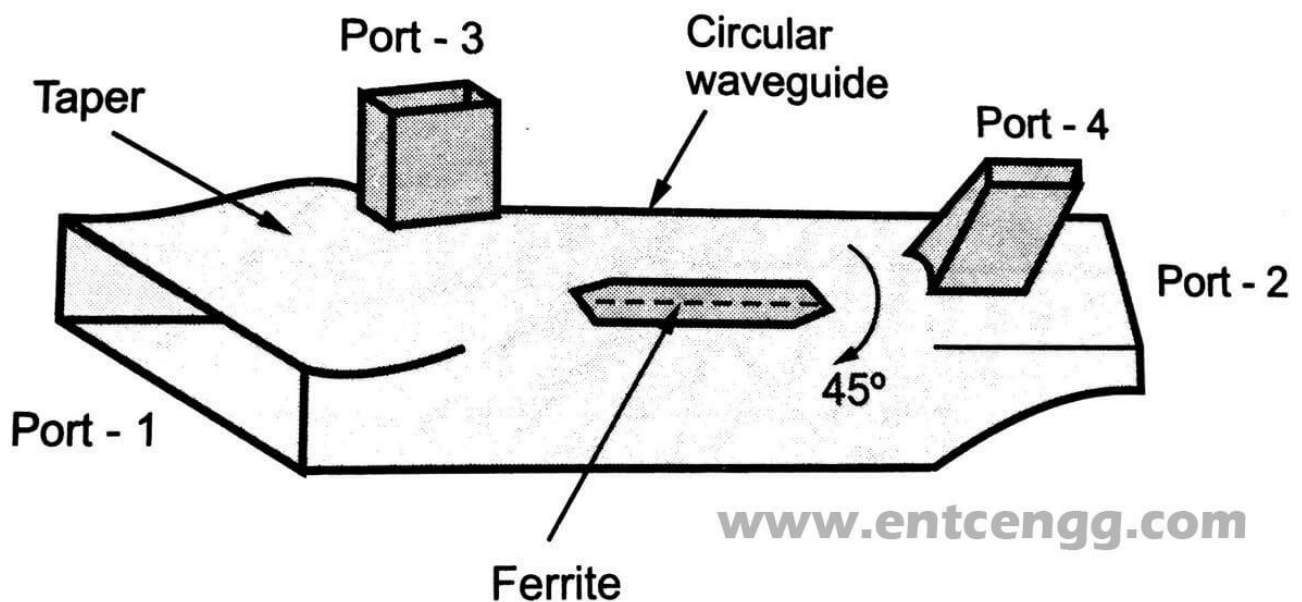

Fig. 2.6.2 Four-port circulator

5. Write short notes on rectangular wave guide with its advantages ?

[2016/2017]

Ans :- **Rectangular Wave Guide** :- A rectangular wave guide is a hollow metallic tube with rectangular cross section . The walls of the guide are conducting and reflection from them takes place .The conducting walls of the guide confine the electromagnetic field and there by guide the Em wave.

There is nothing but air in a wave guide and since the the propagation is by reflection from the wall instead of conductor along them , Power losses in a wave guide are lower than in comparable transmission line.

Mode of Propagation :- The different modes of propagation are TEMn and TMmn mode

TE_mn = Transverse Electric mode

TM_mn= Transverse Magnetic field

m =No. of half wave length across the wave guide width (X)

n =. No. of half wave length along the wave guide height (Y)

Rectangular Waveguide TE/TM Calculations

- Dominant mode (mode with lowest cutoff frequency) for rectangular waveguide is TE_{1,0}.
- A waveguide acts as a high-pass filter in that it passes only those frequencies above the cutoff frequency.

$$v_g v_p = c^2$$

$$\lambda_g = \lambda_o \frac{v_p}{c}$$

$$\lambda_g = \frac{c}{\sqrt{f^2 - f_c^2}}$$

$$\lambda_g = \frac{\lambda_o}{\sqrt{1 - (f_c/f)^2}}$$

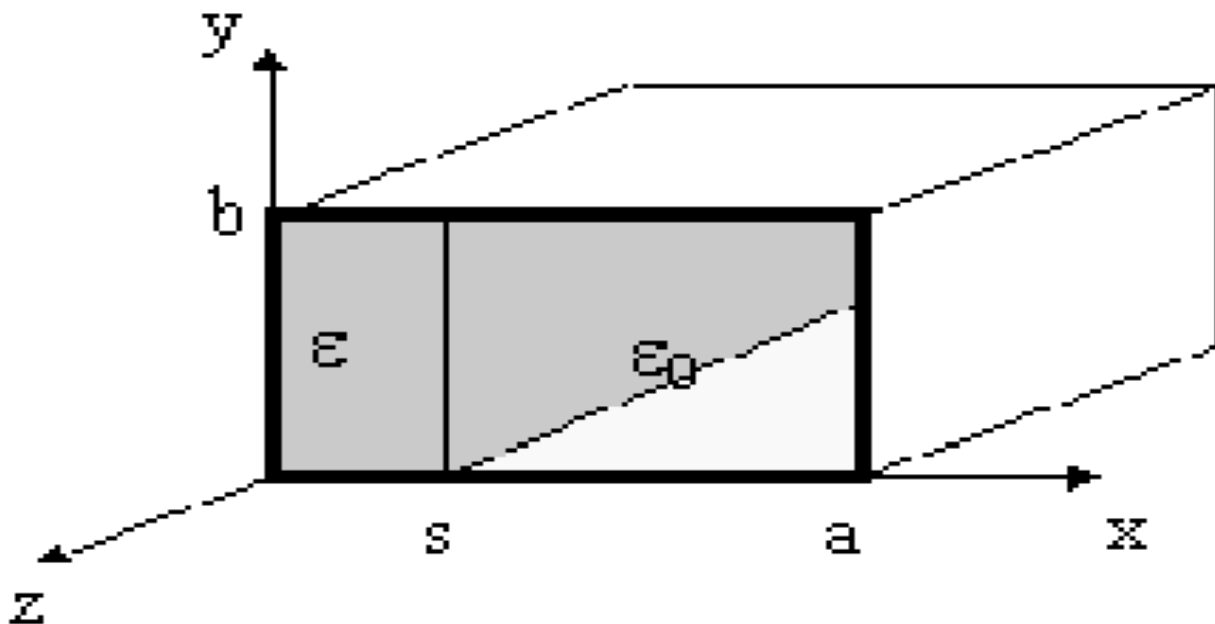

TE mode has electric field at right angle to the direction of propagation . In this mode there is no component of electric field in the direction of propagation.

TM mode has magnetic field at right angle to the direction of propagation . In this mode no component of magnetic field are in the direction of propagation.

TE₁₀ mode is called dominant mode .It is also called natural mode of operation . This mode is the lowest possible frequency. The mode with lowest cutoff frequency or highest cutoff wave length is called dominant mode .

ADVANTAGES :-

It support EM mode propagation with lower loss.

It has high power handling capacity.

It is easy to install.

It has lower attenuation for a given wave length

5.Discuss operation of Cavity Resonator and its Application? [2016/2017]

Ans :-**Cavity Resonator** :- A Cavity resonator is a metallic enclose i.e. a piece of wave guide closed off at both ends, with metallic planes that confines the Emn energy while propagating in the longitudinal direction in the wave guide standing wave exists in the resonator and oscillations can takes place if the resonator is suitably existed .

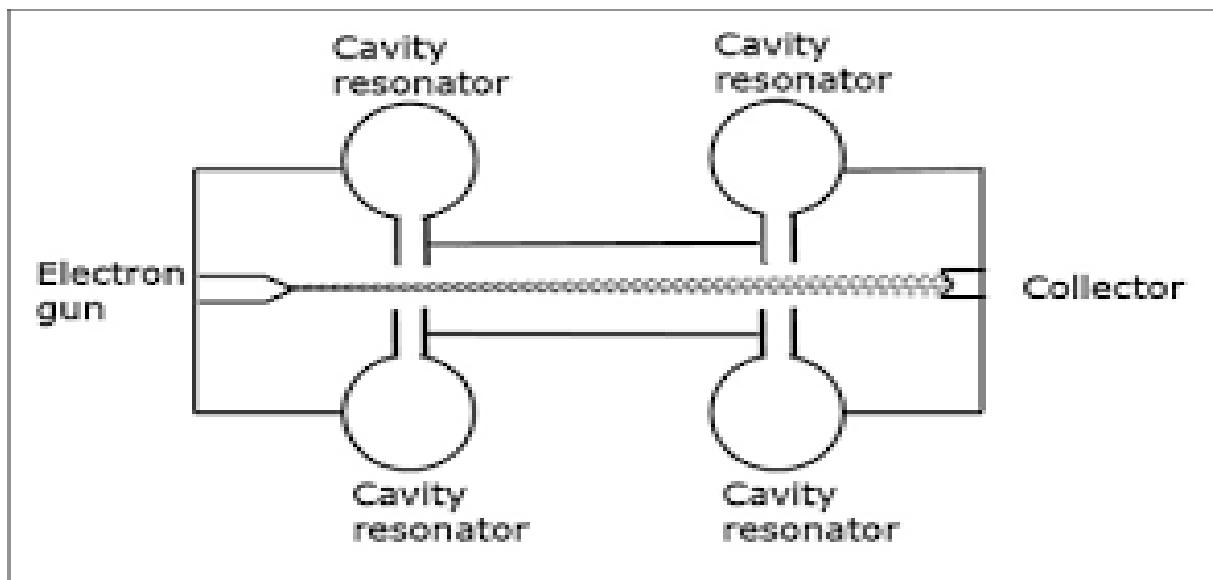

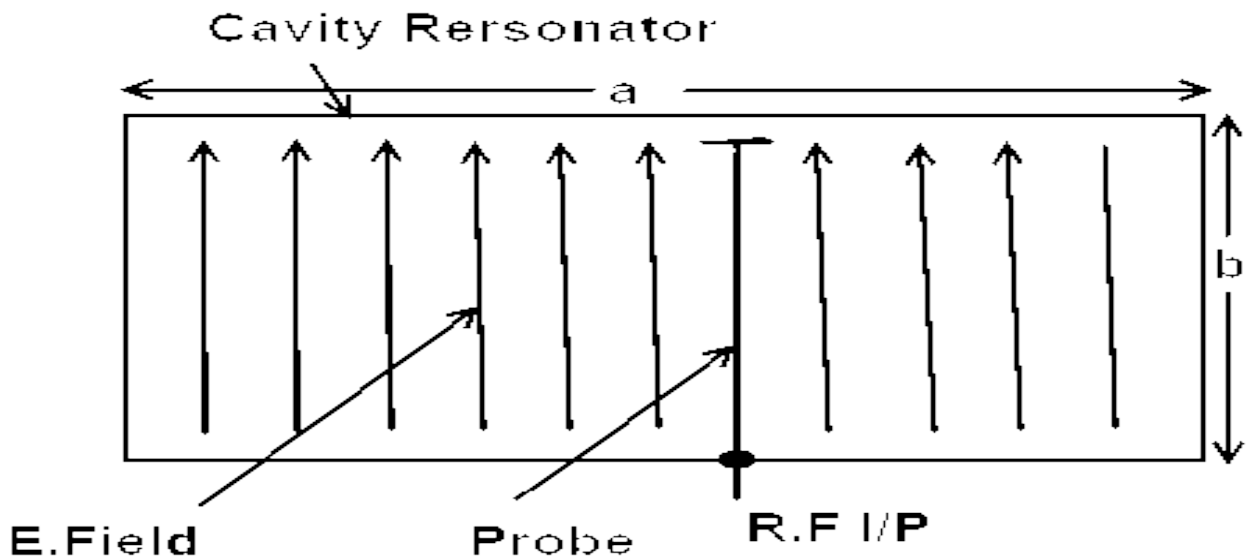

- Its equivalence inductance and capacitance are determined by strong electric and magnetic energies inside the cavity.
- A given resonator has an indefinite numbers of resonant modes and each mode corresponds to a definite resonant frequencies.
- The simplest cavity resonators may be spheres, cylinders or rectangular prism but are very often used due to harmonic problems.
- The general size of a given dominant mode is similar to the cross sectional dimensions of a wave guide carrying a dominant mode of the same signal . If a conducting end walls are placed in the wave guide , then standing waves or oscillations will takes place if source is located between the walls. The distance between the end wall is $n\lambda/2$. Where n is any integer.ome a cavity resonator with its own system of modes and therefore resonant frequencies.

The TE and TM mode numbering system simply speaks the shape of the wave guide but here the resonant frequency is preferable to speak rather than mode.

APPLICATION :-

- It is used as tuned ckt. In transmission line.
- It is used for filtering in conjunction with mixer.
- Used for microwave frequency measuring device

CHAPTER-6

2 marks questions

1. Define SONET and ISDN ?

[2016]

Ans :-SONET :-

SONET is the American National Standards Institute standard for synchronous data transmission on optical media. The international equivalent of SONET is synchronous digital hierarchy (SDH). Together, they ensure standards so that digital networks can interconnect internationally and that existing conventional transmission systems can take advantage of optical media through tributary

attachments.

ISDN :-

Integrated Services Digital Network (ISDN) is a set of communication standards for digital telephone connection and the transmission of voice and data over a digital line. These digital lines are commonly telephone lines and exchanges established by the government. Before ISDN, it was not possible for ordinary telephone lines to provide fast transportation over a single line.

Long Questions (5marks & 7 marks)

1. Write short notes on SONET and ISDN ?

[2017]

ISDN :-

Integrated Services Digital Network (ISDN) is a set of communication standards for digital telephone connection and the transmission of voice and data over a digital line. These digital lines are commonly telephone lines and exchanges established by the government. Before ISDN, it was not possible for ordinary telephone lines to provide fast transportation over a single line.

ISDN was designed to run on digital telephone systems that were already in place. As such, it meets telecom's digital voice network specifications. However, it took so long for ISDN to be standardized that it was never fully deployed in the telecommunications networks it was intended for.

ISDN takes all kinds of data over a single telephone line at the same time. As such, voice and data are no longer separated as they were in earlier technologies, which used separate lines for different services. ISDN is a circuit-switched telephone network system, but it also allows access to packet-switched **networks**.

ISDN is also used with specific protocols, such as Q.931, where it acts as the network, data link and physical layers in the OSI model. Therefore, in broad terms, ISDN is actually a suite of transmission services on the first, second and third layers of the OSI model.

SONET :-

Synchronous optical networking (SONET) is a standardized digital communication protocol that is used to transmit a large volume of data over relatively long distances using a fiber optic medium. With SONET, multiple digital data streams are transferred at the same time over optical fiber using LEDs and laser beams.

SONET is not that different from other technologies, but hardware was manufactured to provide better **configuration** and reliable services to its users. SONET may use a re-generator for long haul distances. This device boosts signals that have already traveled for a long distance. Signals are transmitted into electrical signals and then re-generated into high-power signals. Add drop multiplexers (ADMs) are also common parts of SONET. ADMs are designed to fully support the network architecture of SONET.

SONET supports multiple data streams at the same time. It was designed to provide efficient **services** in telecommunication systems and therefore became widely adopted. SONET uses standardized rates so that all kinds of organizations can be interconnected.

In packet-oriented **networks**, a single packet normally consists of two parts: the data header and the payload. During transmission, the data header is transferred first and then the payload is transmitted. With SONET, however, a slight change is made. The header is termed as overhead and is not transmitted before the payload. Instead, it is interwoven with the payload during the process of transmission. The transmission alternates between overhead and payload until the completion of the transmission process.

